



ELEVATOR CAB  
RENOVATIONS™

+



ELEVATOR  
INTERIORS  
& FIXTURES

# BRISTOL CEILING

MODEL:  
BRISTOL

## INSTALLATION INSTRUCTIONS



## TOOLS REQUIRED

- Measuring Tape
- Drill
- Ladder
- 3" Paint Brush and latex paint for painting the perimeter of the canopy (If required)

## CAB COMPONENTS TO BE INSTALLED

Ceiling mounts

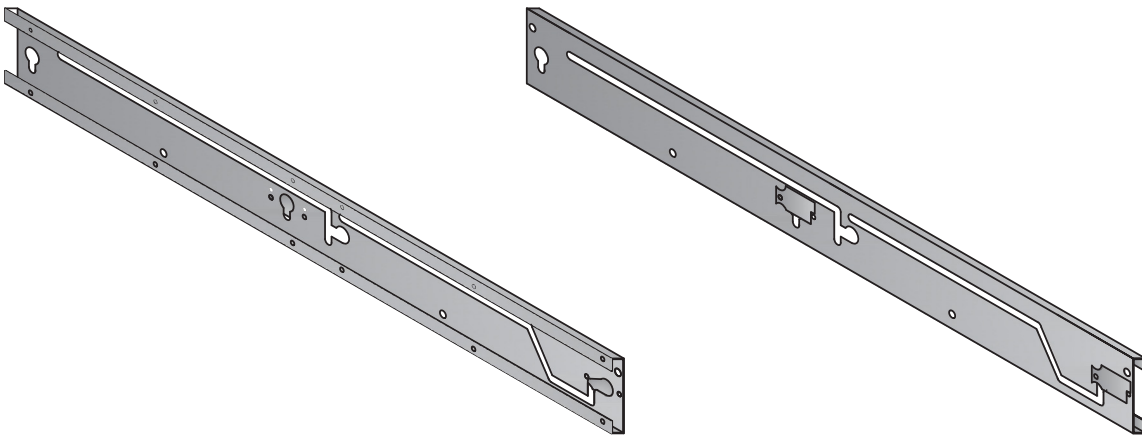

Fixed ceiling panel

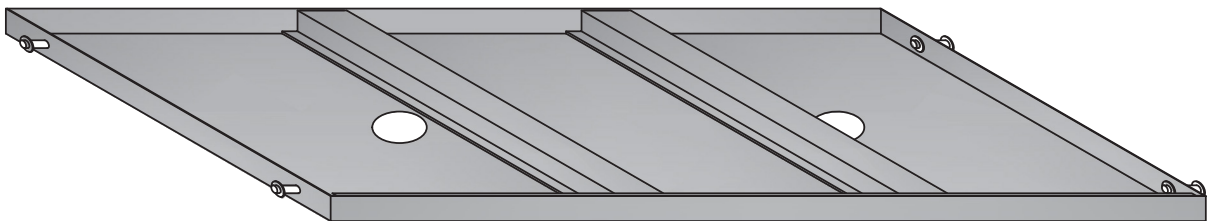

NOTE THE INTERLOCKING  
FLANGE TO  
DIFFERENTIATE THE  
FIXED FROM THE  
MOVABLE CEILING

Movable ceiling panel

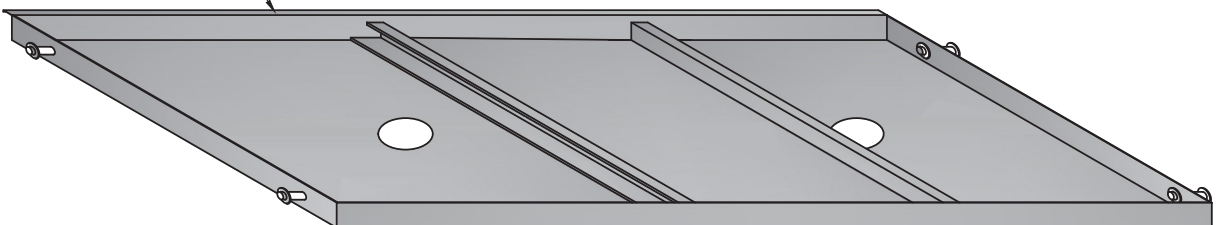

## SECTION 1: UNPACKING

- 1.1. When your new Bristol ceiling arrives, transport it near to the cab you will be renovating and organize the crates so that they will be easily accessible.

The crates contents are itemized on its surface.

- 1.2. Carefully un-crate the ceiling package, making sure that none of the components are damaged.
- 1.3. Check the colours, features, and dimensions of the components against your order before you begin removing the existing elevator ceiling.

If you have any questions at this point, contact ECR before going ahead with any part of the installation.

For technical support on the Bristol Ceiling installation, please contact us at:

**Elevator Cab Renovations**  
Office: (613) 745-4870  
Toll Free: 1-877-745-4870  
[ecr@elevatorcabs.ca](mailto:ecr@elevatorcabs.ca)

Office Hours : 6:30 AM to 3:30 PM Eastern Standard Time

## SECTION 2: PREPARE FOR THE CEILING INSTALLATION

- 2.1. Unless specified otherwise, your new Bristol ceiling will be inset from the shell walls by approximately 2" on all sides. Please consult drawings accompanying ceiling.
- 2.2. Prepare canopy surface to accept the new Bristol ceiling by completing one of the following options
  - a) Sand, clean and re-paint the perimeter of the canopy with a desired color. Black or white are typical for this type of application
  - b) If the canopy is in good condition, a simple cleaning may be all that is required.



Note: It is suggested that for both options a or b, a minimum of 6" of the perimeter of the canopy should be addressed by the process chosen.

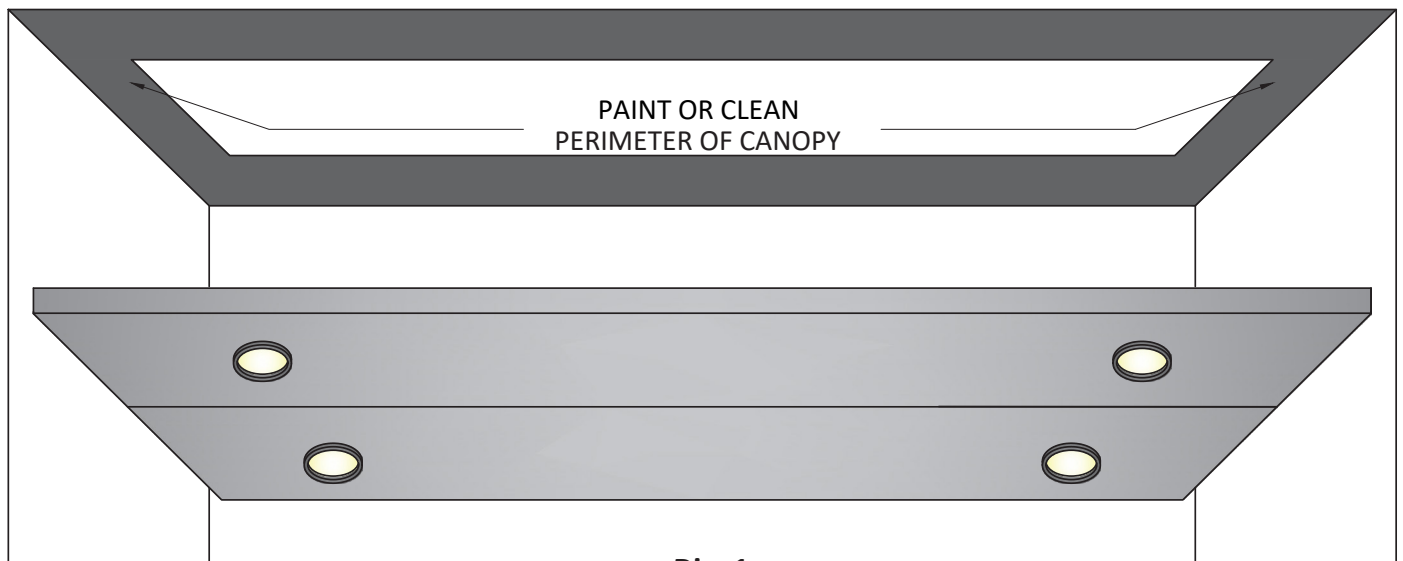

**Dia. 1**  
Canopy preparation.



Note: The Bristol ceiling requires two people to install safely; no additional lifting aids are required.

## SECTION 3: CEILING INSTALLATION

- 3.1. Before installing the mounts, ensure the area above the wall finishes has been appropriately addressed (painted or optional SS reveal).
- 3.2. Locate and mark the center of the side wall. To have a 6" ceiling drop, the bottom of the mount must be installed 5" below the cab canopy. Mark and drill holes for fasteners, install the mounts to the walls through the pre punched holes (Dia. 3).



Note: The track determines the location of the movable ceiling panel. Refer to the diagram for the correct orientation of the mounts.

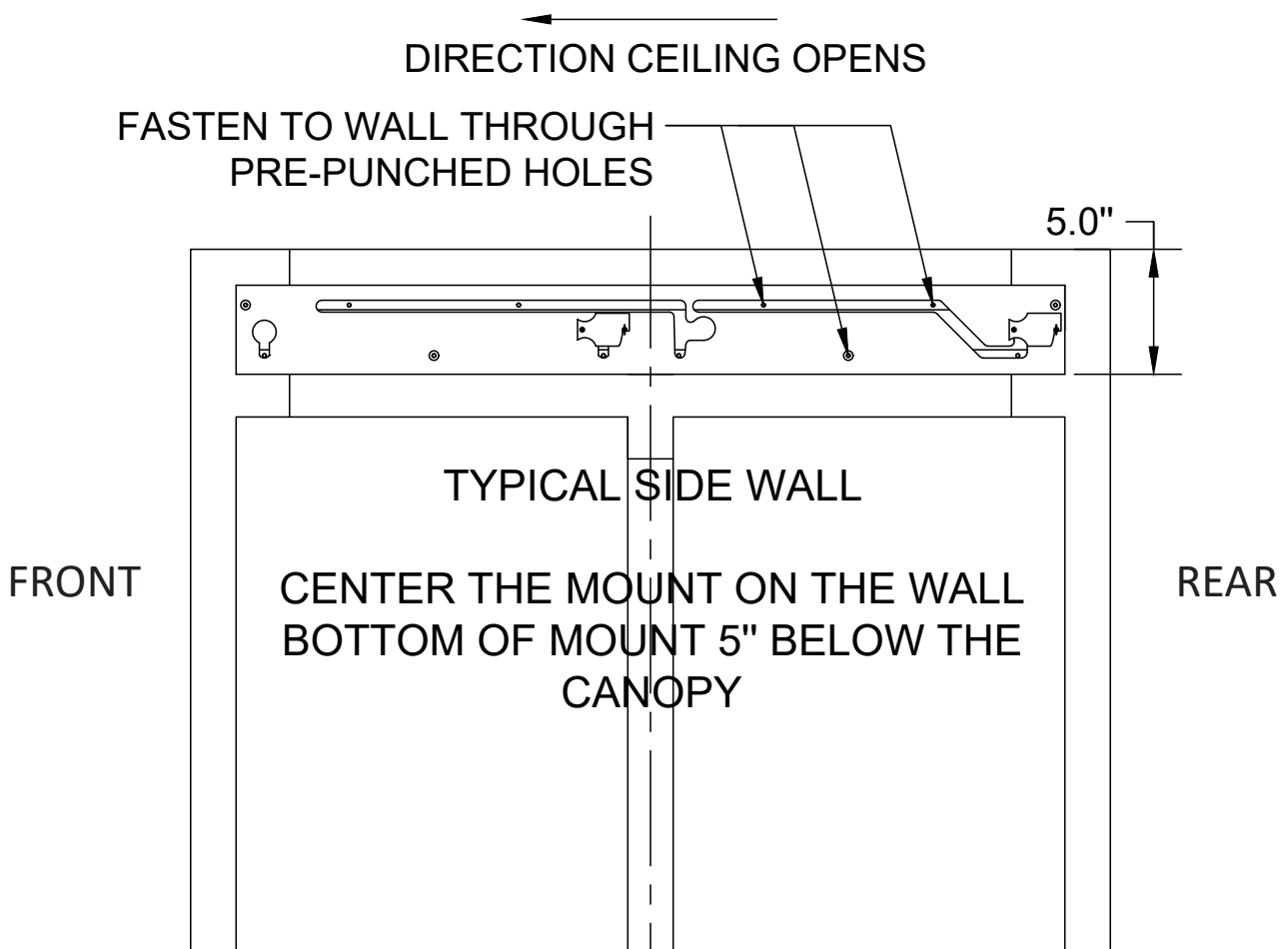

**Dia. 2**  
Aligning the mounts

## SECTION 3: CEILING INSTALLATION (CONTINUED)

3.3. Begin with the fixed ceiling panel. Loosen the wing nuts on the locking plates and rotate the locking plates to the unlocked position (Dia. 3).

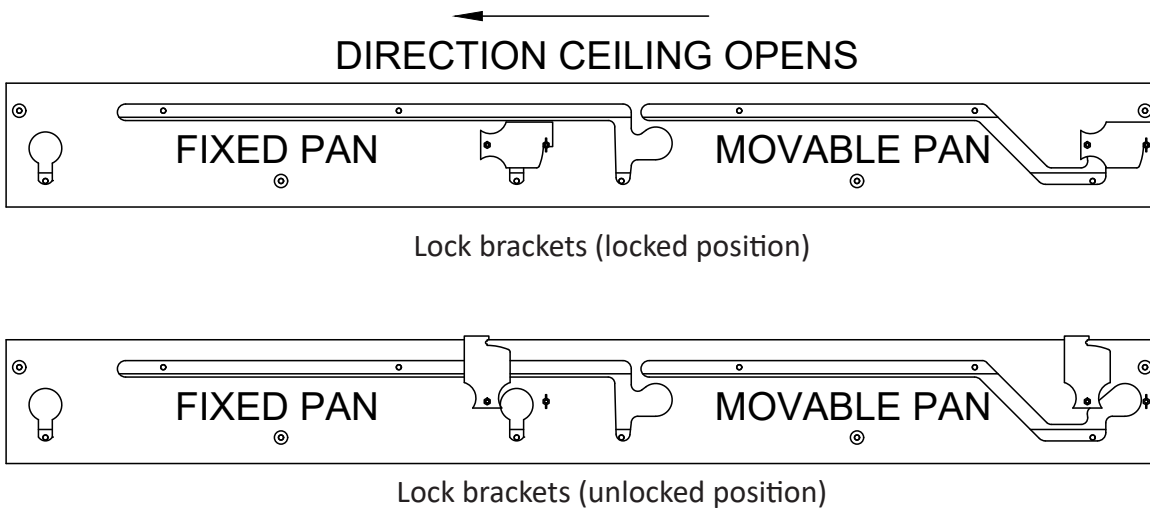

**Dia. 3**



Note: The disk lights have been temporarily inserted into the ceiling panels for transport. Before installing the ceiling panels, you should remove the lights from the ceiling panels and store them in a safe location.

3.4. The support bolts will be pre-installed in the ceiling panels (Dia. 4).

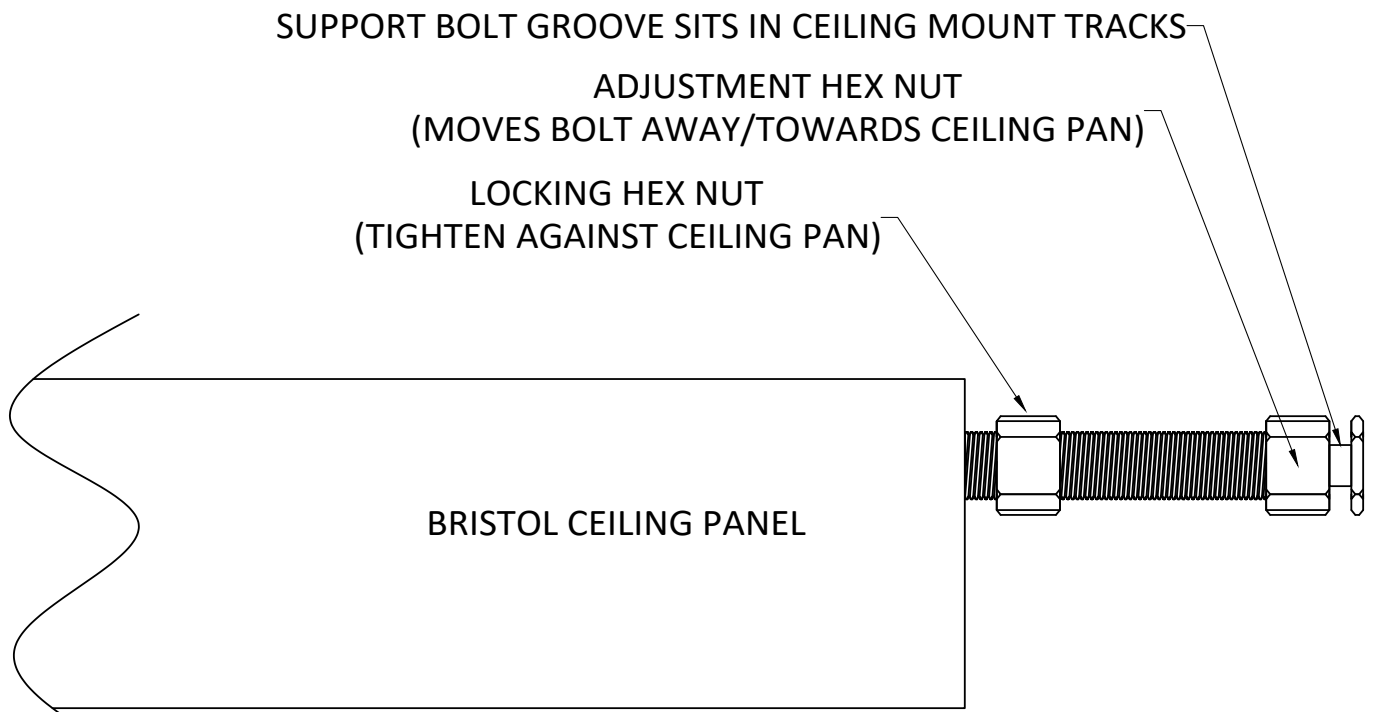

**Dia. 4**

Support bolt detail

## SECTION 3: CEILING INSTALLATION (CONTINUED)

- 3.5. Lift one side of the fixed ceiling panel into position, aligning the support bolts with the corresponding holes in the wall brackets (Dia. 5).

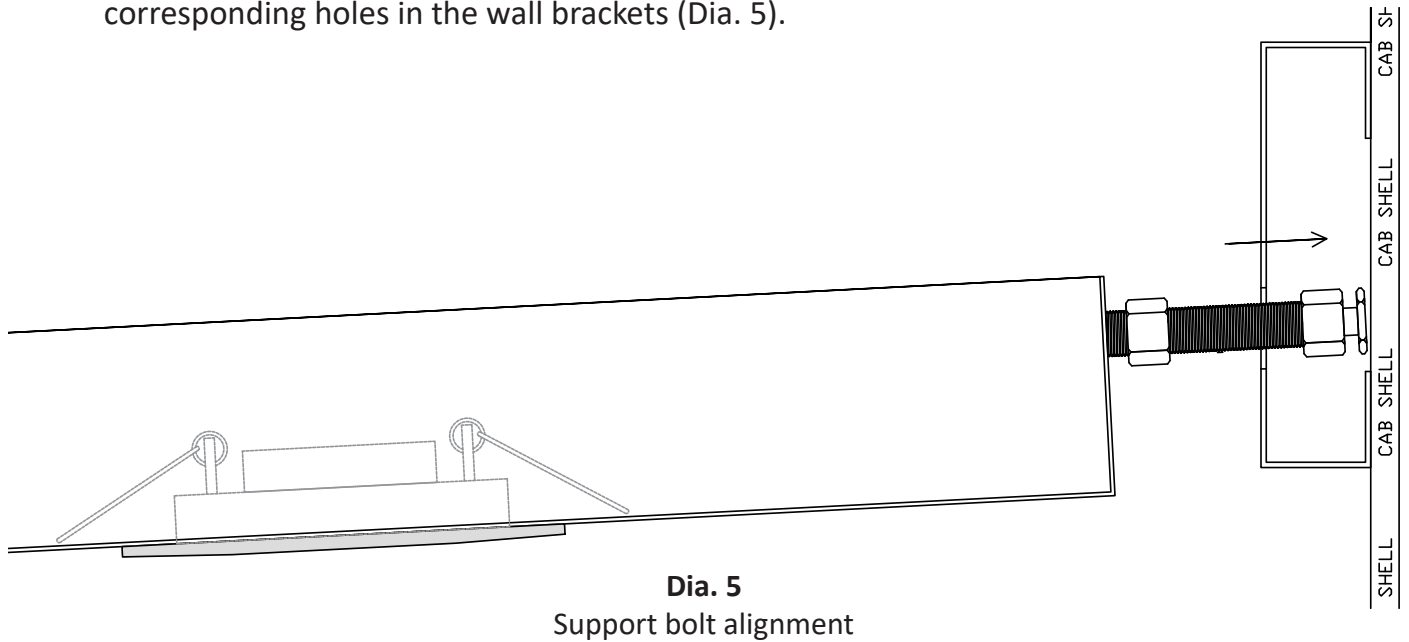

- 3.6. Push one side of the fixed ceiling panel and support bolts into the wall bracket holes as deep as possible (DIA. 5); this will allow enough clearance to swing the opposite side of the fixed ceiling panel up to the opposite support and corresponding alignment holes (Dia. 6).

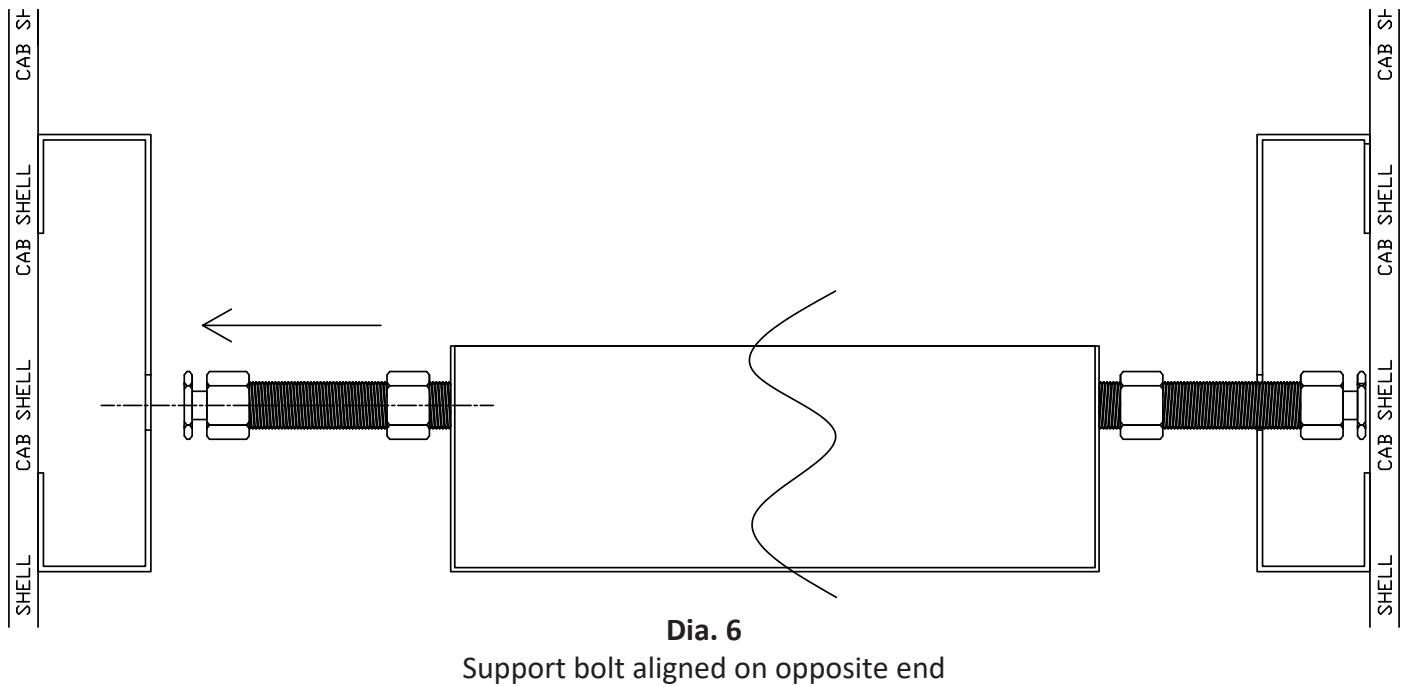

## SECTION 3: CEILING INSTALLATION (CONTINUED)

- 3.7. Slide the fixed ceiling panel into the opposite track so the groove in the support bolts engage with the track (Dia. 7).



Note: Ensure all supports bolts are fully engaged on the wall mounting bracket tracks.

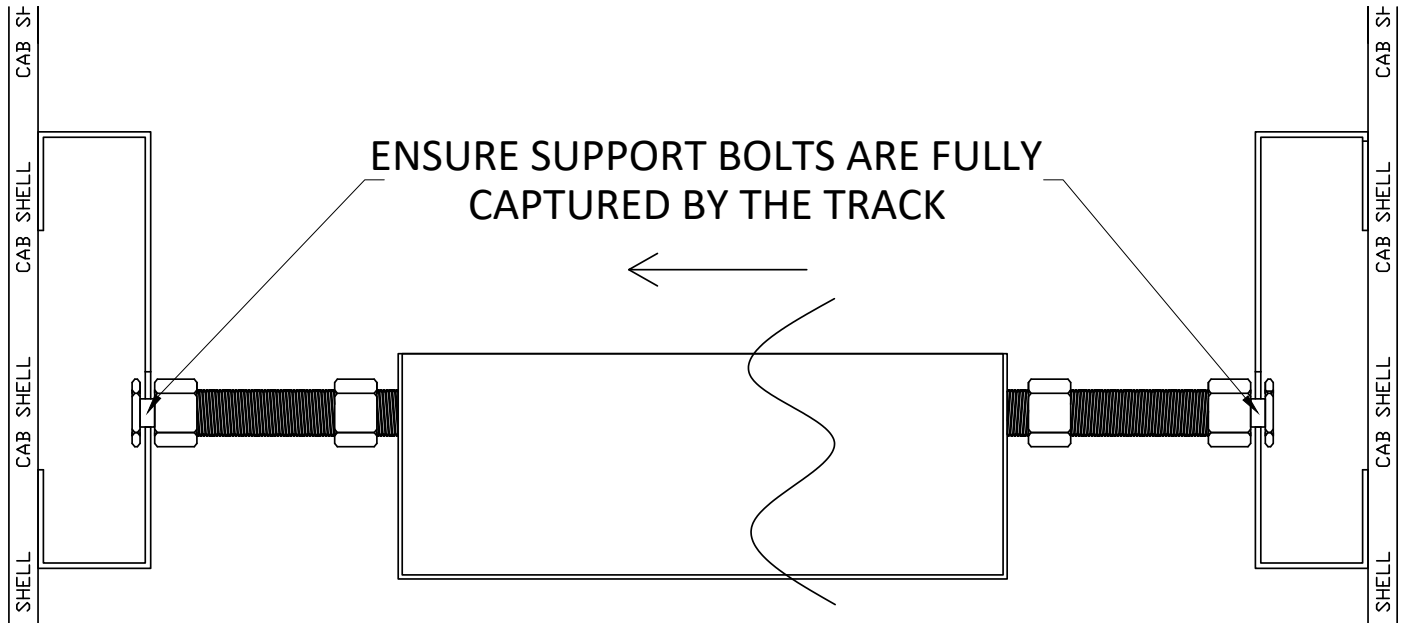

**Dia. 7**

Both support bolts engaged

- 3.8. Center the fixed ceiling panel in the cab using the adjusting hex nuts. Once satisfied, lock the ceiling in place by tightening the locking hex nuts against the ceiling panel (ref Dia. 4).



## SECTION 4: ELECTRICAL CONNECTIONS



Before continuing with the movable ceiling panel installation, it is a good time to prepare the electrical connections.

- 4.1. The ceiling power supplies are located on the movable ceiling panel and are mounted to a removable tray that is velcroed to the pan.
- 4.2. The lighting system runs on 110V AC through a dimmer to a low voltage power supply. The installer must provide 110V to the lighting system. The system can be hard wired (utility box and connectors are provided) (Dia. 8).
- 4.3. Mount an electrical utility box (provided) on top of the canopy (outside on the car), preferably at the rear of the car (near the hatch). This will provide the junction for the 110 V from the car top to the 110 V that will feed the power supplies for the disk lights.

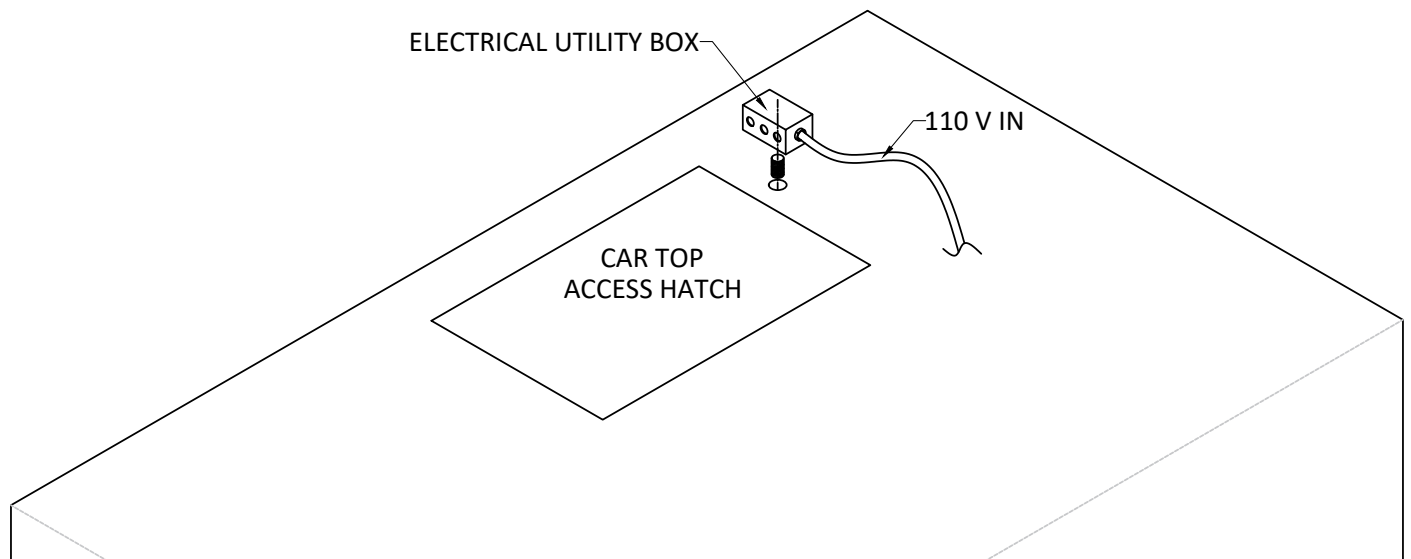

**Dia. 8**

Electrical box on canopy

## SECTION 4: ELECTRICAL CONNECTIONS

- 4.4. Bring the movable ceiling panel close to the install position. Drop the low voltage (white lines) into the 4" disk light holes on the both ceiling panels. Drop the 110 V line (black line) off the back of the ceiling panel.

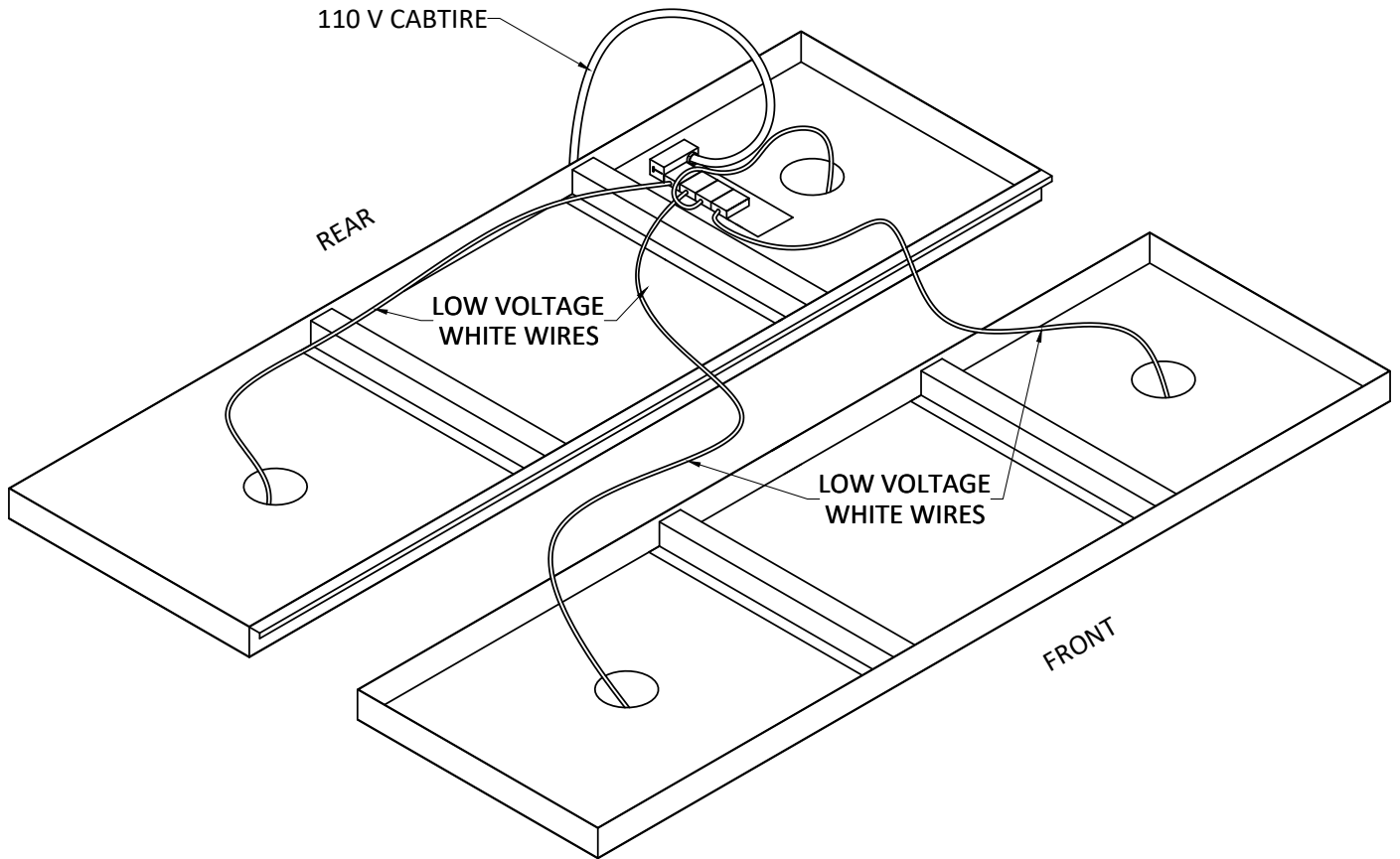

**Dia. 9**  
Wiring setup for Bristol Ceiling

## SECTION 5: FINISH CEILING INSTALL (CONTINUED)



Note: It is crucial to have all locking plates in the closed position during normal operation to ensure the ceiling does not escape the wall mounts.

- 5.2. With the movable ceiling panel in the open position, connect the black wire to the elevators 110 V line through the utility box mounted in section 4.
- 5.3. Connect each of the disk lights to the white low voltage lines. Insert the lights into the ceiling pans using the spring loaded clips.
- 5.4. Adjust the light intensity by accessing the dimmer through the open hatch to set the required light level for your jurisdiction.



Note: Dimmers are only accessible by the installer and should not be altered once illumination levels have been determined.

## SECTION 6: OPENING THE CONVERTIBLE CEILING

- 6.1. To open your convertible ceiling, follow the steps outlined below and refer to the diagram provided (Dia. 12).
- 6.2. Lifting at the joint between the front and rear panels, lift the movable ceiling panel (closest to the rear) up until it touches the top of the track.
- 6.3. Push the ceiling up and over the fixed ceiling panel. Allow the track to guide the panel.
- 6.4. Continue sliding the movable portion until it comes to the end of the track. The ceiling is now fully opened.



During regular elevator operation, the ceiling should be in the **closed position**.

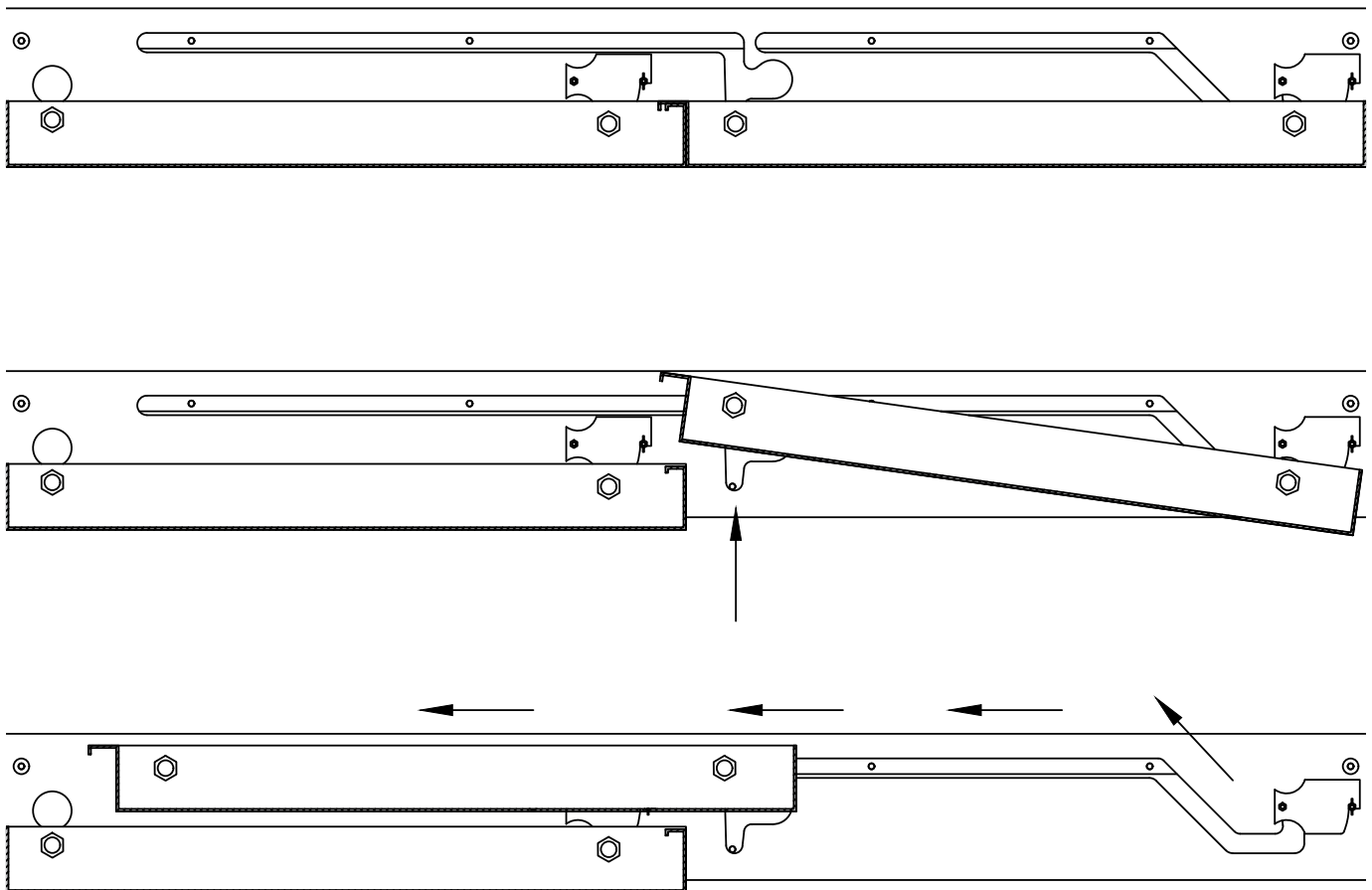

**Dia. 10**  
Opening the Bristol Ceiling

## GLOSSARY

**Canopy:**

The roof of the cab.

The top structural component of the shell.

The canopy houses the emergency hatch.

The canopy may have various electrical and mechanical components attached to its surfaces, both interior and exterior.

For technical support on the Bristol Ceiling installation, please contact us at:

**Elevator Cab Renovations**  
**Office: (613) 745-4870**  
**Toll Free: 1-877-745-4870**  
[ecr@elevatorcabs.ca](mailto:ecr@elevatorcabs.ca)

Office Hours : 6:30 AM to 3:30 PM Eastern Standard Time