



DISPLAY  
**Giotto**  
V3

**Manuale di Installazione**  
*Installation manual / Notice technique*  
*Installationshandbuch / Manual de Instalación*

V. 3.0



































Consultare il manuale "**Precauzioni d'uso e sicurezza**"  
Refer to the "**Safety and usage precautions**" manual  
Consulter manuel technique "**Precautions de securite et d'emploi**"  
Handbuch lesen "**Sicherheits- und Gebrauchsanweisung**"  
Consulte el manual "**Precaucioned de seguridad**"



[www.dmg.it](http://www.dmg.it) / solutions

INDICE • INDEX

- |                                                  |         |
|--------------------------------------------------|---------|
| 1) LAYOUT                                        | pag. 4  |
| 2) MONTAGGIO • MOUNTING                          | pag. 5  |
| 3) COLLEGAMENTI • WIRING                         | pag. 7  |
| 4) PROGRAMMAZIONE • PROGRAMMING                  | pag. 20 |
| 5) CARATTERISTICHE TECNICHE • TECHNICAL FEATURES | pag. 35 |

VERSIONI <i>VERSIONS</i>		INGRESSI / INPUTS			
		SERIAL <i>inputs</i>		MULTIPARALLEL <i>inputs</i>	CAN BUS <i>inputs</i>
<b>Giotto 4,3"</b>					
	Standard	<b>DT4RSS00M.DG</b>	<b>DT4RSP00M.DG</b>	<b>DT4RS100M.DG</b>	<b>DT4RSC00M.DG</b>
		<b>DT4RSS00M.DS</b> 	<b>DT4RSP00M.DS</b> 	<b>DT4RS100M.DS</b> 	<b>DT4RSC00M.DS</b> 
	Vandal-Proof Version <b>81-71</b> class 2	<b>DT4RVS00M.DG</b>	<b>DT4RVP00M.DG</b>	<b>DT4RV100M.DG</b>	<b>DT4RVC00M.DG</b>
		<b>DT4RVS00M.DS</b> 	<b>DT4RVP00M.DS</b> 	<b>DT4RV100M.DS</b> 	<b>DT4RVC00M.DS</b> 
<b>Giotto 5,6"</b>					
	Standard	<b>DT5RSS00M.DS</b> 	<b>DT5RSP00M.DS</b> 	<b>DT5RS100M.DS</b> 	<b>DT5RSC00M.DS</b> 
		<b>DT5FSS00M.DS</b> 	<b>DT5FSP00M.DS</b> 	<b>DT5FS100M.DS</b> 	<b>DT5FSC00M.DS</b> 
	Firefighters Version <b>81-72</b>				
<b>Giotto 7"</b>					
	Standard	<b>DT7RSS00M.DS</b> 	<b>DT7RSP00M.DS</b> 	<b>DT7RS100M.DS</b> 	<b>DT7RSC00M.DS</b> 
		<b>DT7RVS00M.DS</b> 	<b>DT7RVP00M.DS</b> 	<b>DT7RV100M.DS</b> 	<b>DT7RVC00M.DS</b> 
	Vandal-Proof Version <b>81-71</b> class 2				
		<b>DT7FSS00M.DS</b> 	<b>DT7FSP00M.DS</b> 	<b>DT7FS100M.DS</b> 	<b>DT7FSC00M.DS</b> 

## 1 LAYOUT

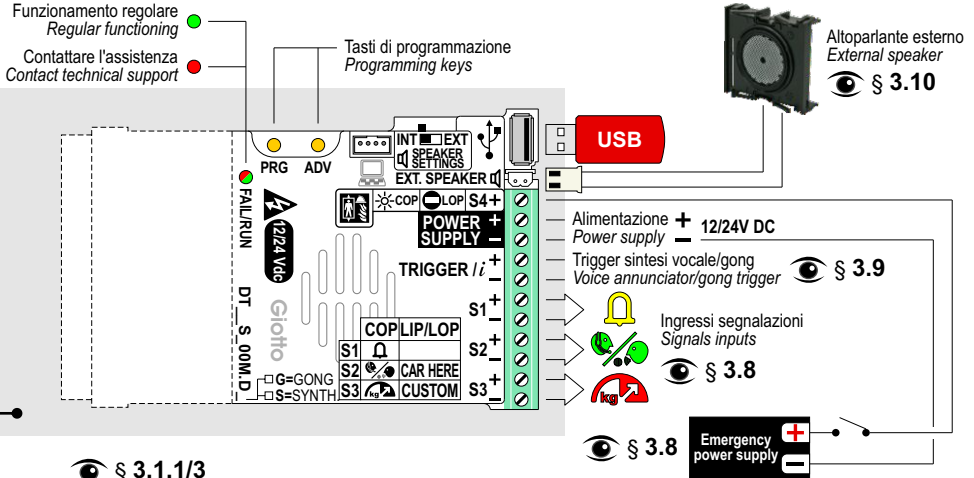

§ 3.1.1/3



Linea seriale precabliata *Pre-wired serial line*  
 Frece di prossima direzione *Next direction arrows*

Encoder DEUM § 3.1.2/4

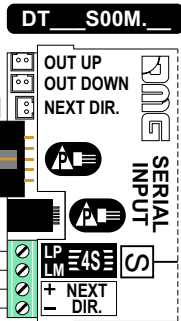

Frece di prossima direzione *Next direction arrows*

§ 3.2-6  
 Ingressi paralleli di posizione *Parallel position inputs*

Ingressi frecce *Arrows inputs*

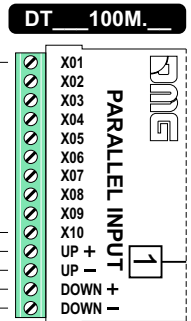

Linea seriale precabliata *Pre-wired serial line*



§ 3.1.1/3

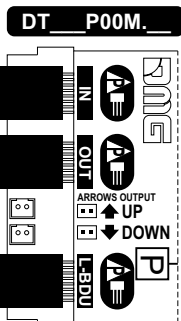

Resistenza di terminazione *Termination resistor*

CAN H  
 CAN L  
 § 3.7

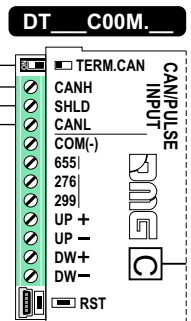

## 2 MONTAGGIO • MOUNTING

FICHE DE MONTAGE • MONTAGEANLEITUNG • INSTRUCCIONES DE MONTAJE

### 2.1 GIOTTO 4,3" / 5,6" Con perni saldati su piastre 1,5÷3 mm With studs on 1,5÷3 mm faceplate

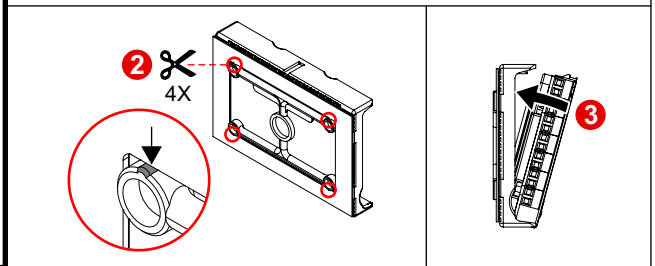
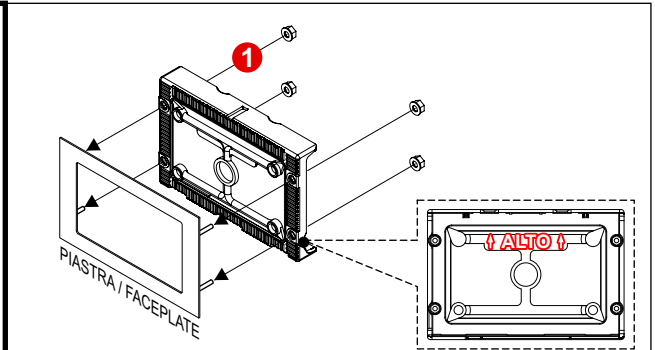
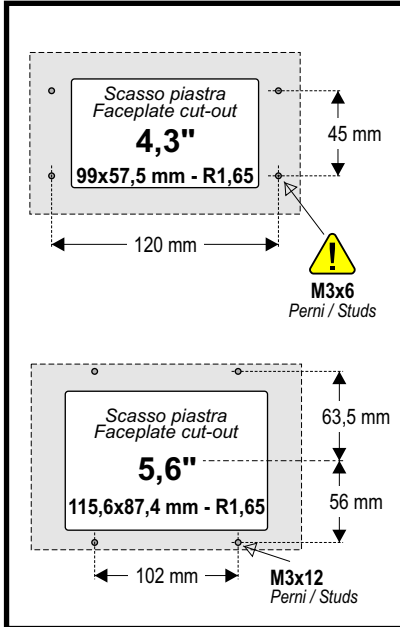

### 2.2 GIOTTO 7" Con perni saldati su piastre 1,5÷3 mm With studs on 1,5÷3 mm faceplate

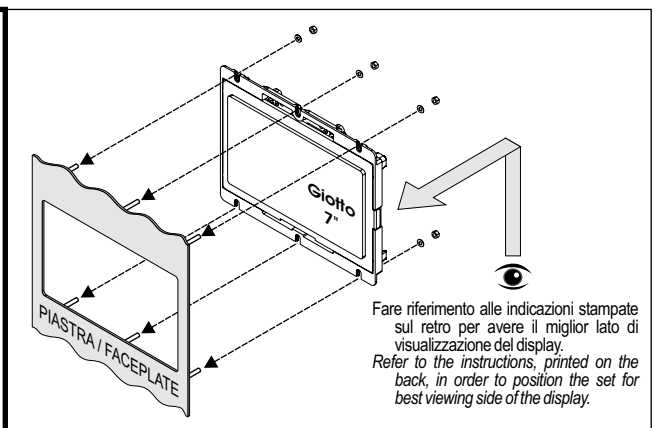
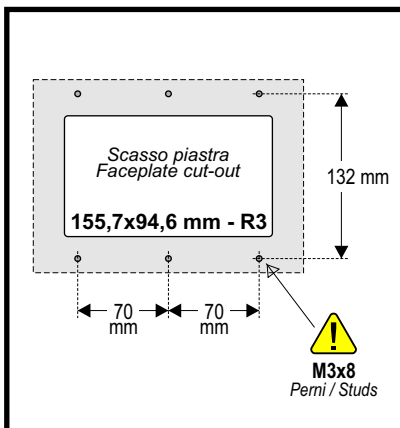

In caso di sostituzione di display esistente verificare che la lunghezza dei perni sia ≤ 8mm ed eventualmente accorciarli.  
If you are replacing an existing position indicator, please verify that studs' length is ≤ 8mm; if not, shorten them.

## 2.3 GIOTTO 4,3" Vandal-Proof Version

**81-71** class 2

Con perni saldati su piastre 2+3 mm  
With studs on 2+3 mm faceplate

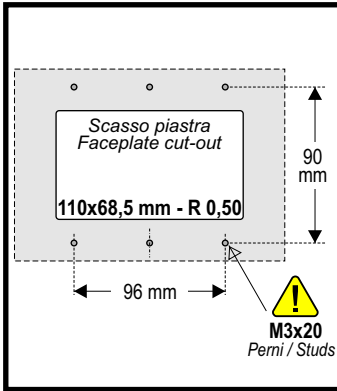

Solo per piastre di 2mm / 2mm thicknes plate only

per piastre di 2/3mm  
2/3mm thicknes plate **81-71** ✓  
class 2

per piastre di 1,5mm  
1,5mm thicknes plate ~~81-71~~ ✗  
class 2

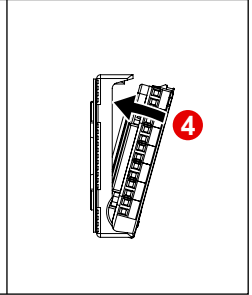
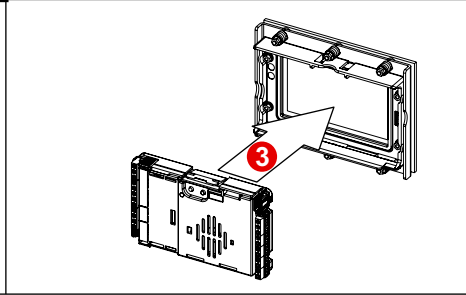
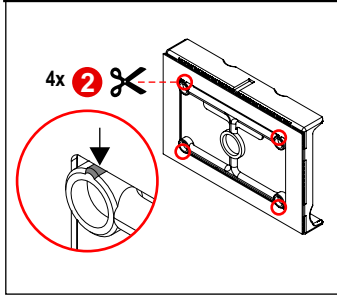
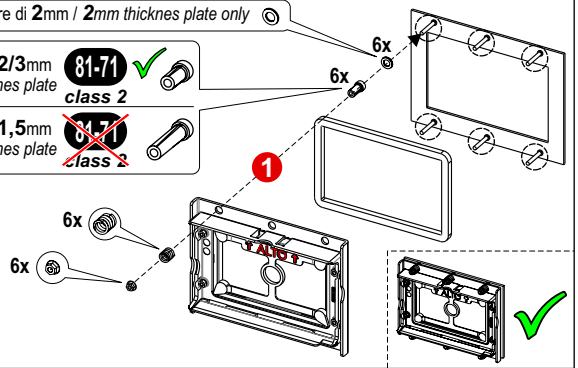

## 2.4 GIOTTO 7" Vandal-Proof Version

**81-71** class 2

Con perni saldati su piastre 2+3 mm  
With studs on 2+3 mm faceplate

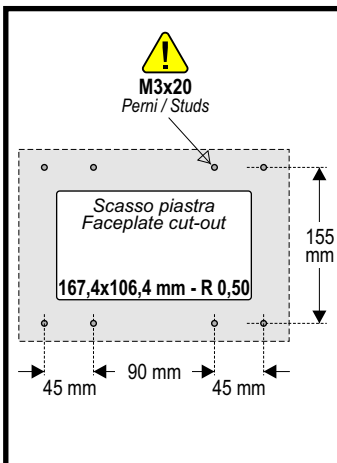

Solo per piastre di 2mm / 2mm thicknes plate only

per piastre di 2/3mm  
2/3mm thicknes plate **81-71** ✓  
class 2

per piastre di 1,5mm  
1,5mm thicknes plate ~~81-71~~ ✗  
class 2

Fare riferimento alle indicazioni stampate sul retro per avere il miglior lato di visualizzazione del display.  
Refer to the instructions, printed on the back, in order to position the set for best viewing side of the display.

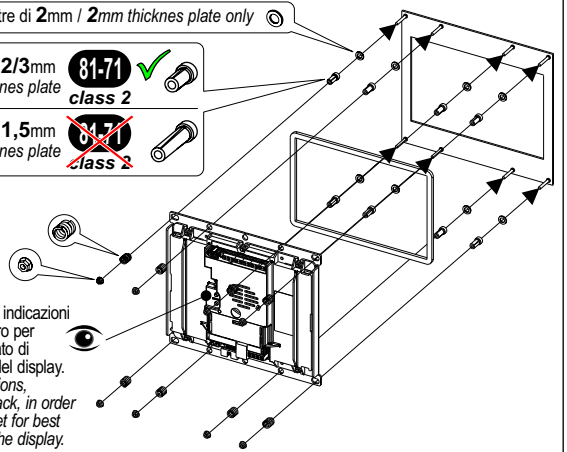

## 3 COLLEGAMENTI • WIRING

BRANCHEMENTS • ANSCHLÜSSE • CONEXIONES

### 3.1 Collegamento con linea SERIALE • SERIAL BUS wiring

Liaison série • Serielles Protokoll • Protocolo serie

#### 3.1.1 Cablaggio in CABINA con sistema Pitagora DMG

CAR wiring with DMG Pitagora system • Branchements CABINE avec système Pitagora DMG

Anschlüsse KABINE mit DMG Pitagora system • Conexiones de CABINA con instalación Pitagora DMG

A 1

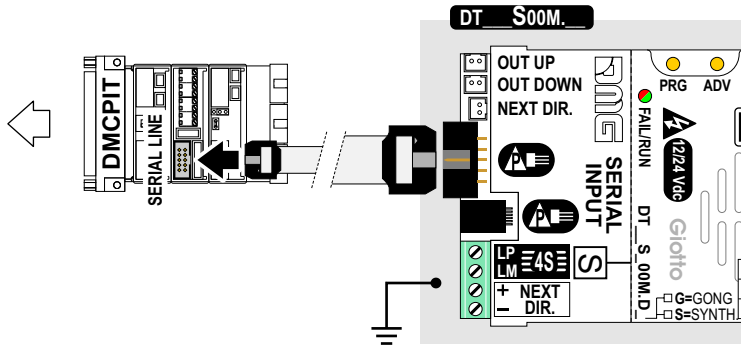

A 2

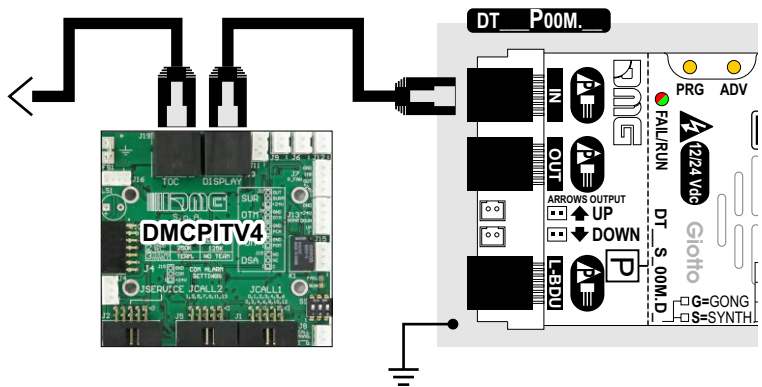

B

### Impostazione display in cabina • Car position indicator setting

Programming MENU

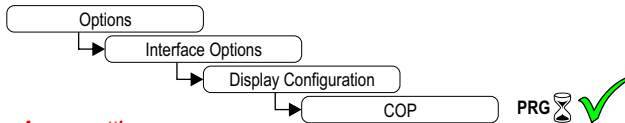

### Impostazione frecce • Arrows setting

Programming MENU

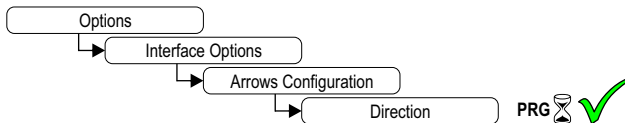

C

### 3.1.2

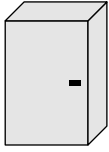

**Cablaggio in CABINA con altri quadri**  
*CAR wiring with other controllers*  
*Branchements CABINE avec autre armoire*  
*Anschlüsse KABINE mit anderen Steuerungen*  
*Conexiones de CABINA con otro cuadro*

## A

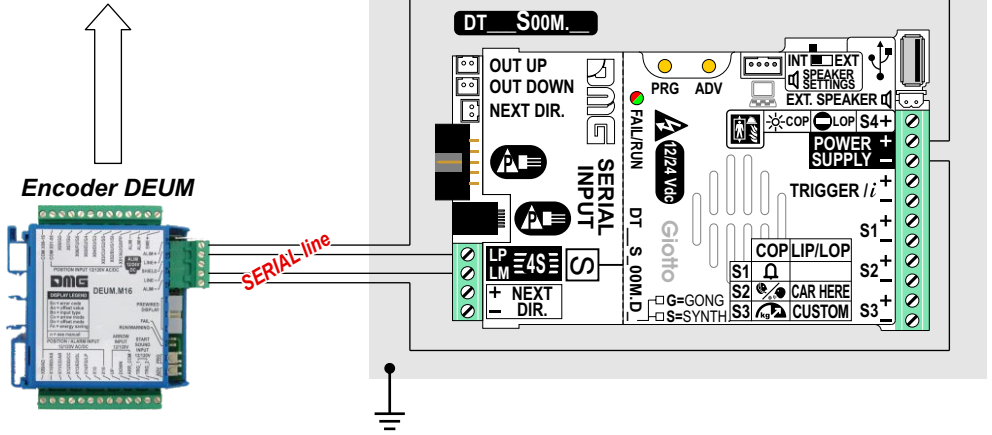

### Impostazione display in cabina • Car position indicator setting

## B

👁 § 3.1.1

### Impostazione frecce • Arrows setting

## C

👁 § 3.1.1



**3.1.3** **Cablaggio ai PIANI con sistema Pitagora DMG**  
**FLOOR wiring with DMG Pitagora system • Branchements PALIERS avec système Pitagora DMG**  
**Anschlüsse ETAGEN mit DMG Pitagora system • Conexiones de PISOS con instalación Pitagora DMG**

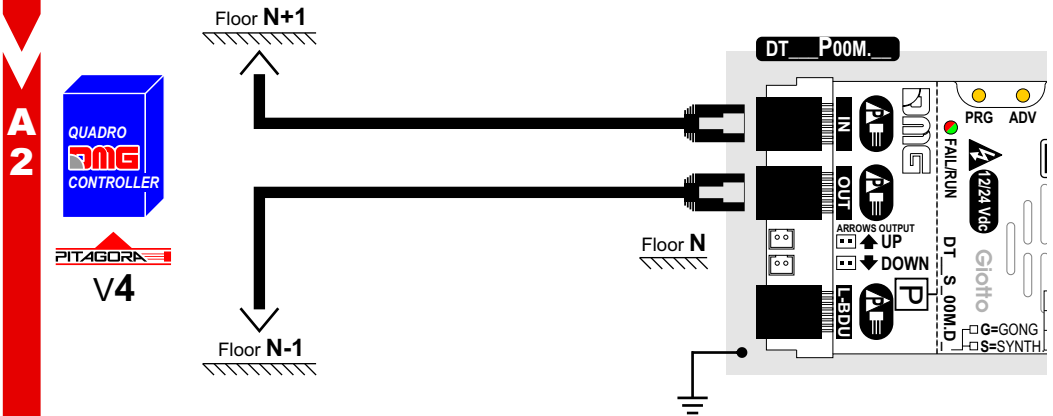
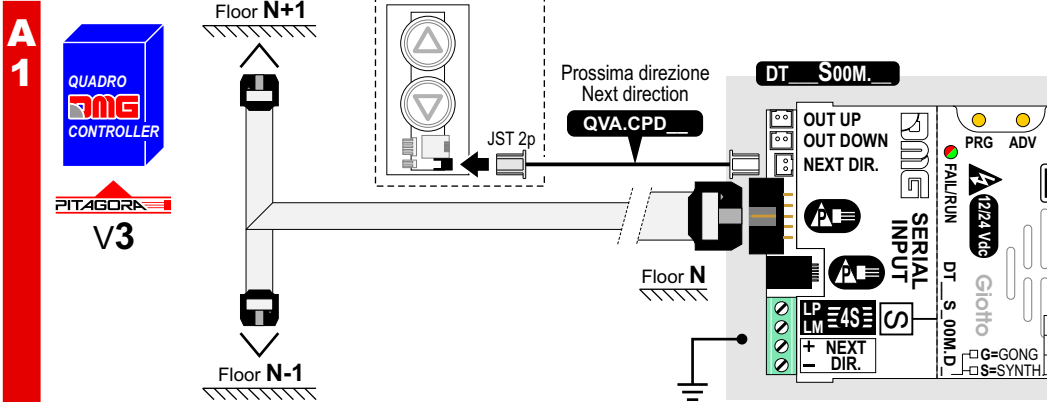

**Impostazione display di piano • Floor position indicator setting**

Programming MENU

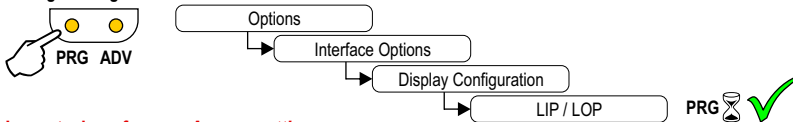

**Impostazione frecce • Arrows setting**

Programming MENU

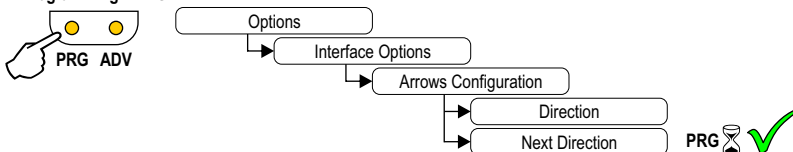

### 3.1.4

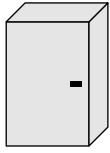

**Cablaggio ai PIANI con altri quadri**  
*FLOOR wiring with other controllers*  
*Branchements PALIERS avec autre armoire*  
*Anschlüsse ETAGEN mit Anderen Steuerungen*  
*Conexiones de PISOS con otro cuadro*

## A

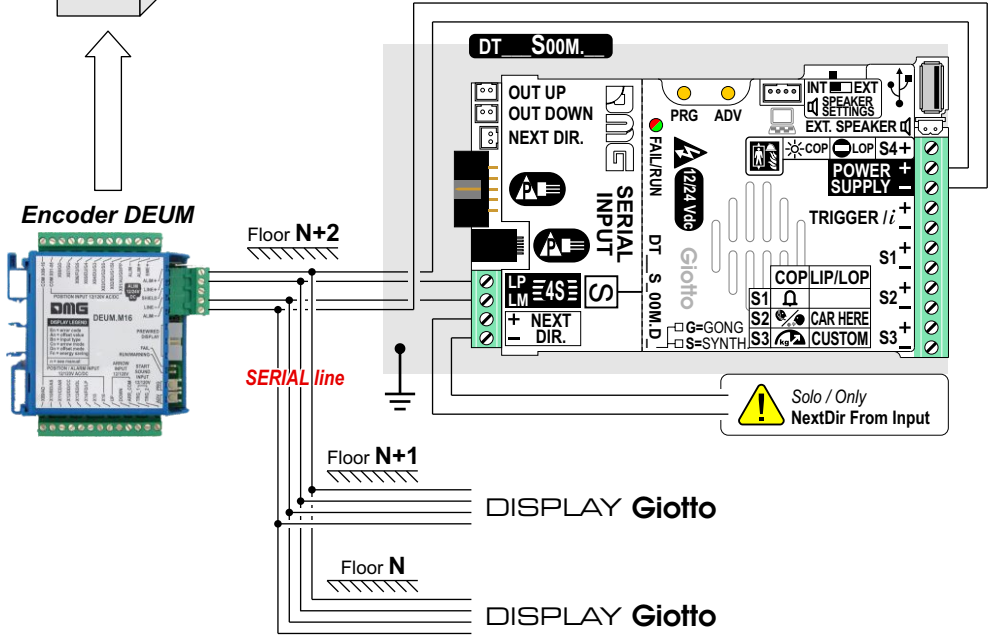

## B

**Impostazione display di piano • Floor position indicator setting**

§ 3.1.3

## C

**Impostazione frecce • Arrows setting**

§ 3.1.3

## 3.2 Collegamento in parallelo (1 FILO / PIANO) • Parallel wiring (1 LINE / FLOOR) Liaison 1 fil par niveau • 1 Draht je Etage Protokoll • Protocolo 1 hilo por piso

**A**

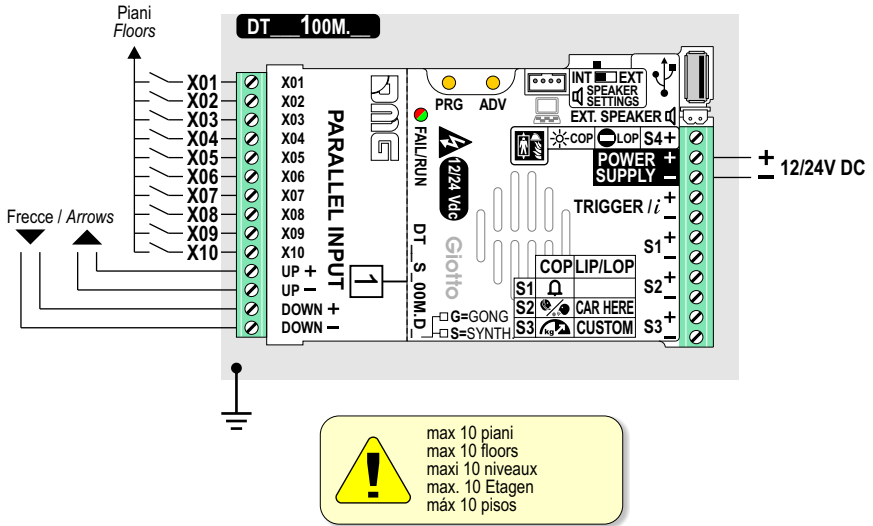

**B**

### Impostazione protocollo • Protocol setting

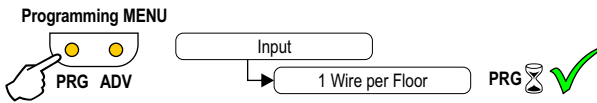

**C**

### Impostazione display di cabina (COP) o di piano (LIP/LOP) • Car (COP) or floor (LIP/LOP) position indicator setting

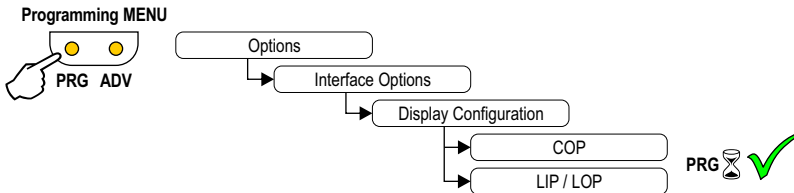

**D**

### Impostazione comune ingressi • Inputs common setting

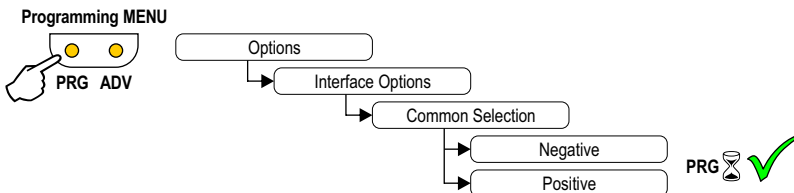

### 3.3 Collegamento in parallelo (1 FILO / SEGMENTO) • Parallel wiring (1 LINE / SEGMENT) Liaison 1 fil par segment • 1 Draht je Segment Protokoll • Protocolo 1 hilo por segmento

**A**

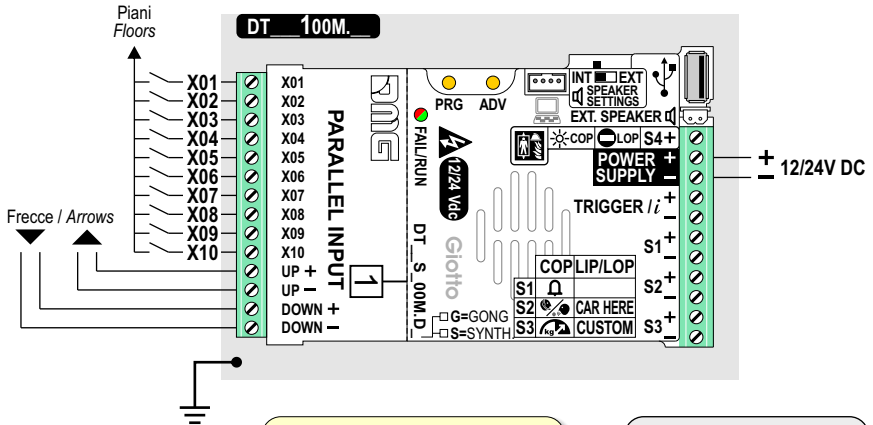

**B**

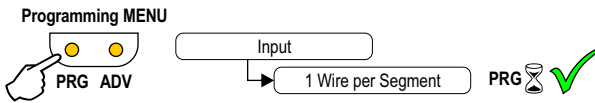

### Impostazione protocollo • Protocol setting

**C**

§ 3.2

### Impostazione comune ingressi • Inputs common setting

**D**

§ 3.2

**3.4** **Collegamento in parallelo (GRAY / BINARIO) • Parallel wiring (GRAY / BINARY)**  
Liaison Gray / Binaire • Gray / Binär Protokoll • Protocollo Gray / Binario

**A**

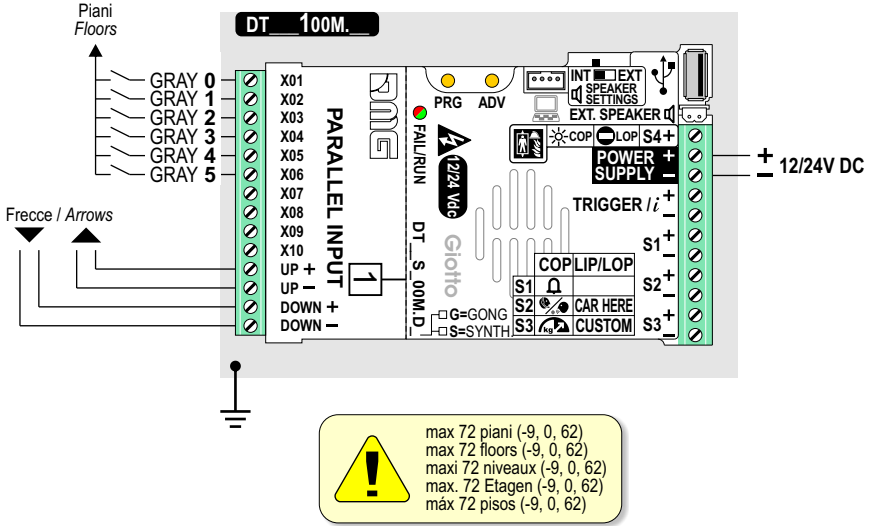

**B**

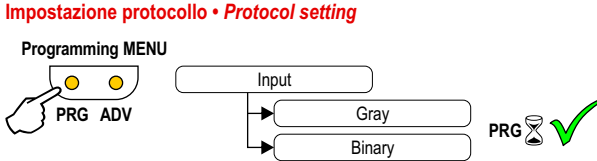

**C**

**Impostazione display di cabina (COP) o di piano (LIP/LOP) • Car (COP) or floor (LIP/LOP) position indicator setting**

§ 3.2

**D**

**Impostazione comune ingressi • Inputs common setting**

§ 3.2

## 3.5 Collegamento SENSORE POSIZIONE INDIPENDENTE (OPTION) INDEPENDENT FLOOR DETECTION wiring (OPTION)

Branchements capteur position indépendant • Anschlüsse mit separatem Positionssensor  
Conexiones de posición independiente

**A**

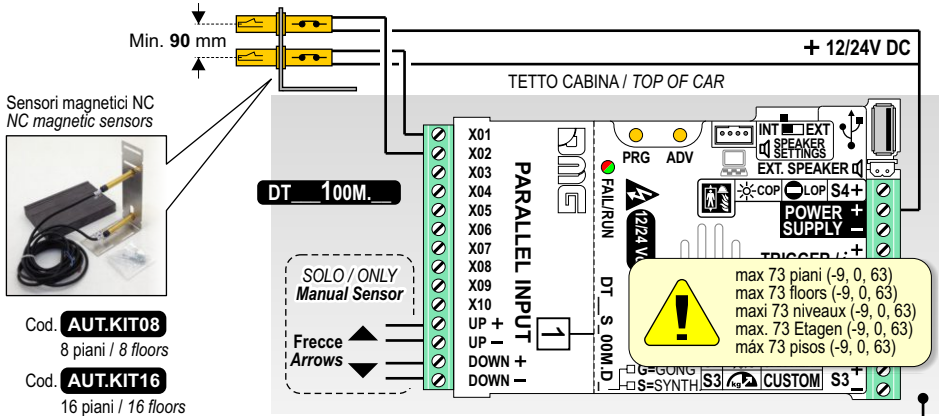

**B**

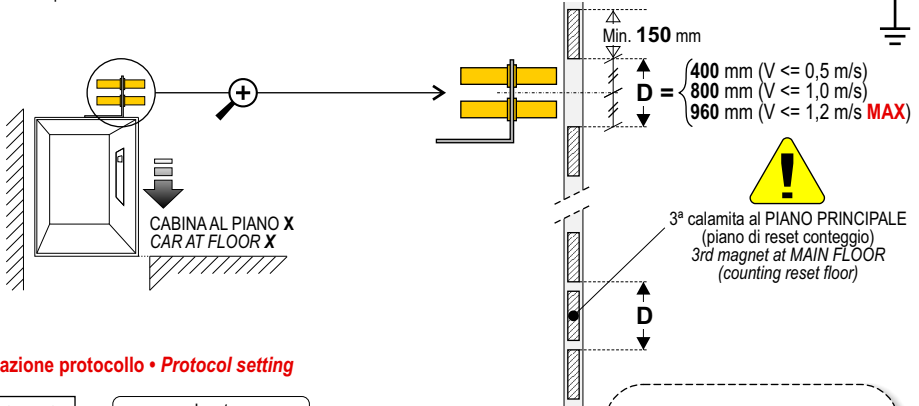

**C**

### Impostazione protocollo • Protocol setting

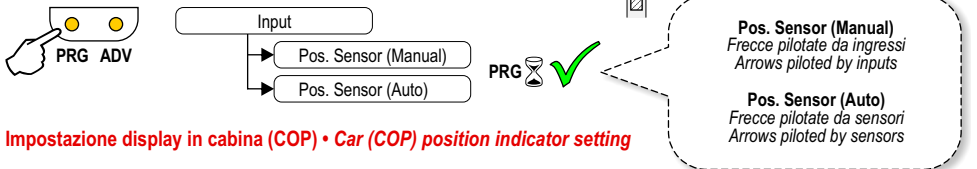

**D**

### Impostazione display in cabina (COP) • Car (COP) position indicator setting

§ 3.2 SOLO come display di CABINA  
CAR position indicator ONLY

**E**

### Impostazione comune ingressi (NEGATIVO) • Inputs common setting (NEGATIVE)

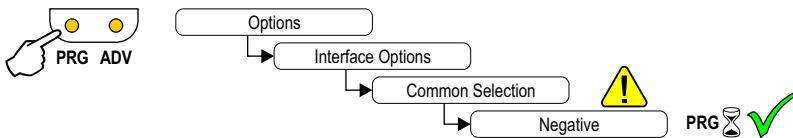

## 3.6

### Collegamento con protocollo TKE/MEA/Autinor • TKE/MEA/Autinor protocol wiring Liaison TKE/MEA/Autinor • TKE/MEA/Autinor Protokoll • Protocolo TKE/MEA/Autinor

#### A

Uscita display quadro di manovra  
Control panel display output  
Sortie afficheur armoire de manoeuvre  
Ausgang Steuerungsanzeige  
Salida indicador cuadro de maniobra

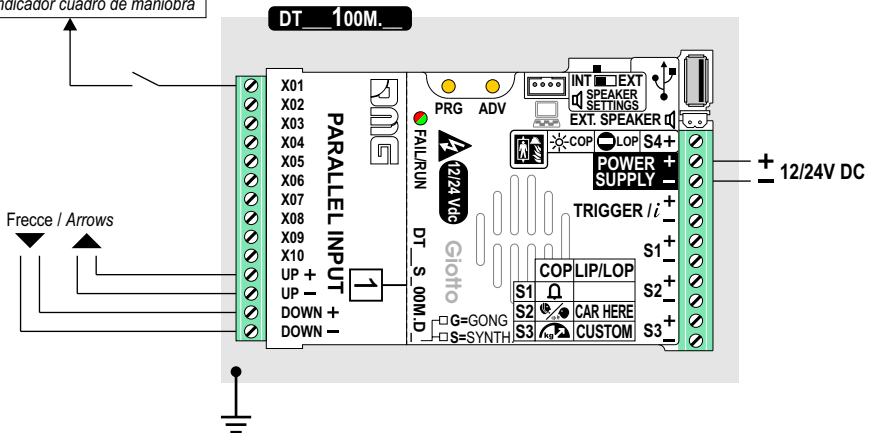

#### B

### Impostazione protocollo • Protocol setting

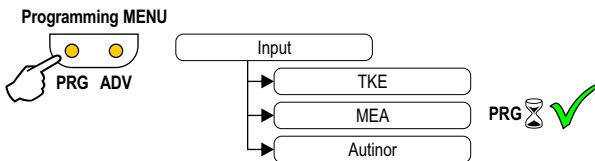

#### C

### Impostazione display di cabina (COP) o di piano (LIP/LOP) • Car (COP) or floor (LIP/LOP) position indicator setting

§ 3.2

#### D

### Impostazione comune ingressi • Inputs common setting

§ 3.2

## 3.7 Collegamento con protocollo CAN BUS • CAN BUS protocol wiring Liaison CAN BUS • CAN BUS Protokoll • Protocollo CAN BUS

**A**

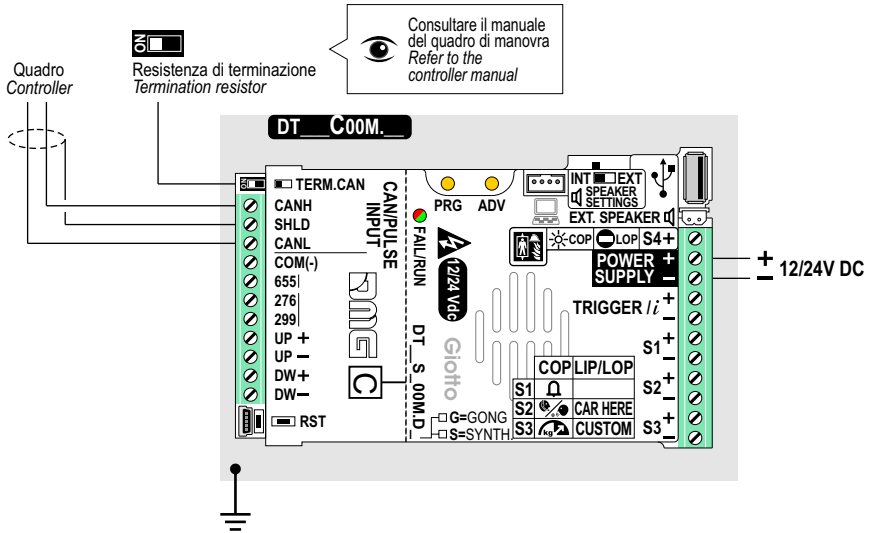

**B**

### Impostazione protocollo • Protocol setting

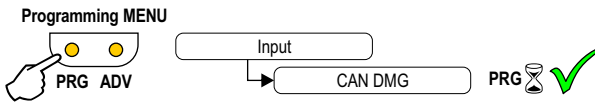

**C**

### Impostazione display di cabina (COP) o di piano (LIP/LOP) • Car (COP) or floor (LIP/LOP) position indicator setting

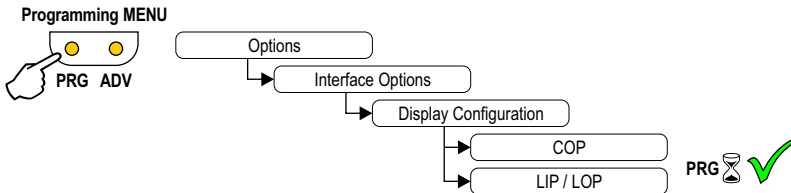



## 3.8 Collegamento SEGNALAZIONI • Connecting SERVICE MESSAGE INPUTS

Branchement voyants • Anschlüsse Anzeigen • Conexiones pilotos

### - Display di CABINA • CAR position indicator -

Programming MENU

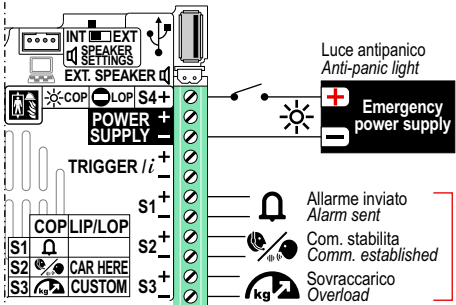
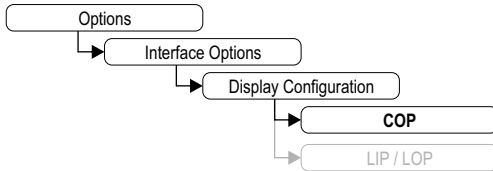

Default

\*

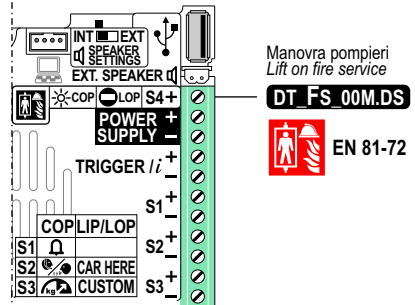

### - Display di PIANO • FLOOR position indicator -

Programming MENU

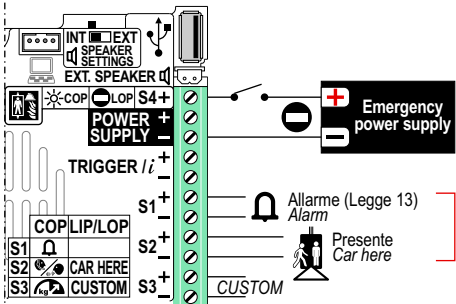
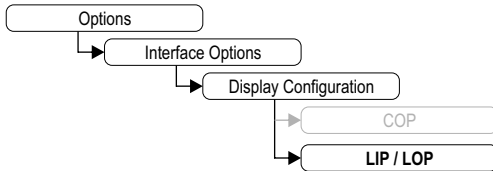

Default

\*

\* Le segnalazioni possono anche essere pilotate via seriale direttamente dal quadro DMG o dall'encoder DEUM.M16  
 Service messages can also be piloted, through serial bus, by the DMG controller or DEUM.M16  
 Les voyants peuvent être gérés en sériel directement de l'armoire DMG ou l'encodeur DEUM.M16  
 Die Anzeigen können seriell direkt von dem DMG Steuerung oder Encoder DEUM.M16 angesteuert werden.  
 Los pilotos también pueden ser controlados directamente en comunicación serie a través del cuadro DMG o del codificador DEUM.M16

**3.9**

**Collegamento TRIGGER • TRIGGER wiring**

Branchement Trigger • Anschlüsse Trigger • Conexiones Trigger

Tramite questo ingresso è possibile avviare la riproduzione dei messaggi di piano e del gong.

This input triggers the voice messages and the gong.

Cette entrée permet d'activer la reproduction des messages d'étage et des gong.

Mit diesem Eingang kann die Wiedergabe der Etagenmeldungen und Gong.

Mediante esta entrada es posible iniciar la reproducción de los mensajes de piso y del gong.

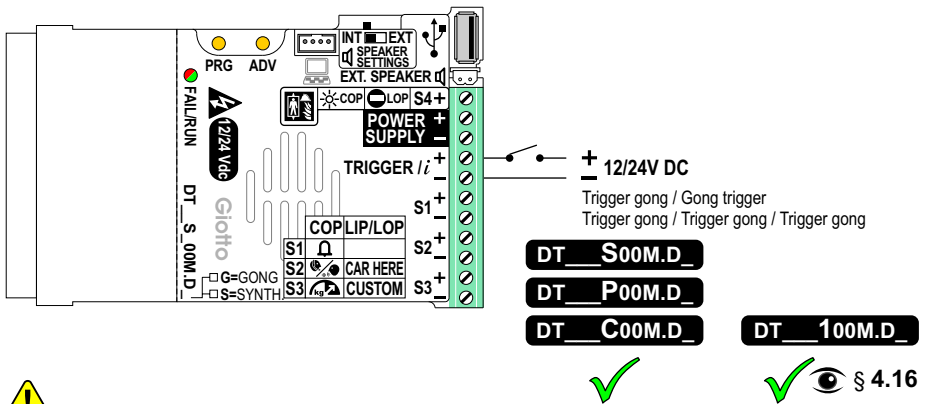

Nel caso di pilotaggio tramite encoder DEUM è preferibile collegare il comando TRIGGER direttamente all'encoder.

If piloting is driven by DEUM ENCODER, a direct connection between the TRIGGER command and the Encoder is suggested.

Si vous utilisez un encoder DEUM il est préférable de connecter le TRIGGER directement sur l'encoder.

Im Falle von Ansteuerung mittels Encoder DEUM, empfiehlt es sich den TRIGGER-Kommando direkt an den Encoder anzuschließen.

En el caso de utilizzo a través del codificador DEUM se aconseja conectar el mando TRIGGER directamente al codificador.

### 3.10 COLLEGAMENTI AVANZATI • ADVANCED WIRING

Branchements avancées • Erweiterte Anschlüsse • Conexiones avanzados

#### 3.10.1 Collegamento FRECCHE ESTERNE

EXTERNAL ARROWS wiring



DT \_\_ S00M.D

DT \_\_ P00M.D

Solo versione con protocollo seriale/Pitagora  
Serial/Pitagora protocol  
version only

A

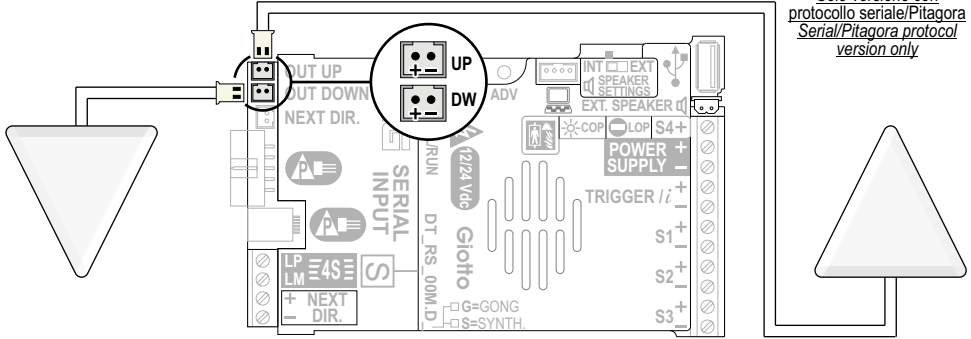

B

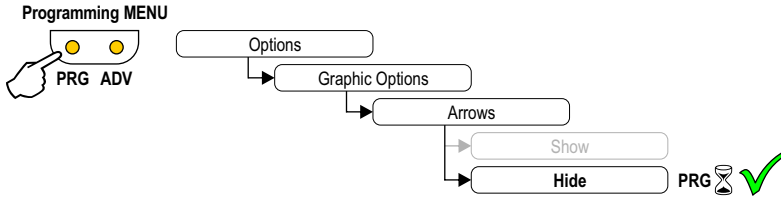

#### 3.10.2 Collegamento ALTOPARLANTE ESTERNO (consigliato per funzione di sintesi vocale)

EXTERNAL SPEAKER wiring (advised for voice annunciator function)



DT \_\_ \_\_.DS

Solo versione con sintesi vocale  
Voice annunciator  
version only

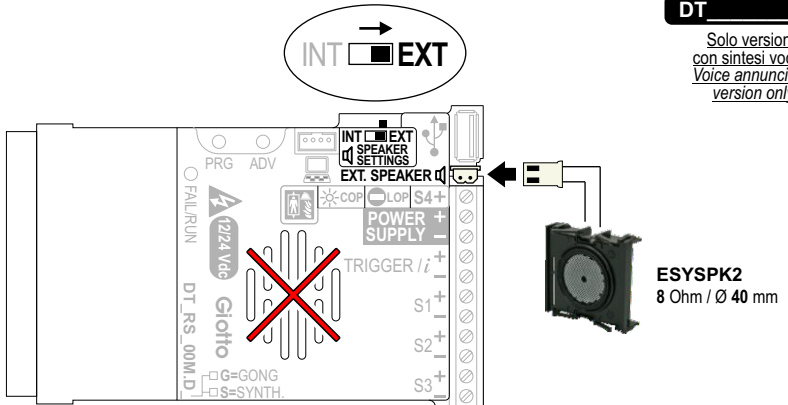

## 4

### PROGRAMMAZIONE • PROGRAMMING

### PROGRAMMATION • PROGRAMMIERUNG • PROGRAMACIÓN

#### MENU map

Tasti di navigazione menu • Navigation menu keys

Touches de navigation du menu • Tasten für die Menünavigation • Teclas de navegación menú

**ADV** Tasto di scelta valore  
Set-up key  
Touche de choix de la valeur  
Taste für die Auswahl eines Werts  
Tecla de elección valor

**ADV** EXIT / BACK

**PRG** Tasto di accesso al menu  
Access menu key  
Touche de accéder du menu  
Taste für Zugang zum Menü  
Tecla de acceso menú

**PRG** Memorizzazione valore (> 3 secondi)  
Value setting (> 3 seconds)  
Sauvegardé valeur (> 3 secondes)  
Angabe-Speicherung (> 3 Sekunden)  
Memorización valor (> 3 segundos)

	MENU	VOCE DEL MENU MENU ITEM	SCELTE DISPONIBILI AVAILABLE CHOICES	INGRESSI / INPUTS				
				Serial Pitagora	Parallelo	CANBUS		
<b>PRG</b>	Input		Serial / 1 wire per floor/segment Gray / Binary / Pos. Sensor (Auto/Manual) TKE / MEA / Autinor / CAN DMG	✓	✓	✓	§ 3.2-7	
	Audio Settings	GongVolume / Floor message Vol. / UP-Down Messages Vol. Buzzer Vol. / Signal Vol. / Chime Vol. / Background Vol.	0-OFF / 1-MIN / 2 / 3 / 4-MAX	✓	✓	✓	§ 4.1	
		Trigger Delay	0, 1, ..., 30	✓	✓	✓	§ 4.2	
		Message Sequence	Gong - Floor - Up/Down	✓	✓	✓	§ 4.3	
	Options	Interface Options	Display Configuration	COP / LOP / LIP	✓	✓	✓	§ 4.4
			Arrows Configuration	Direction / Next.Dir.	✓			§ 4.5
			"Car at Floor"	No / Yes	✓		✓	§ 4.6
			Gong with NO Arrows	No / Yes	✓			§ 4.7
			CAN Baudrate	250k, 125k, 10k			✓	§ 4.8
			Convert Mezzanine	No / Yes	✓			§ 4.9
			Offset Value	-9 / ... / 0 / ... / +9		✓		§ 4.10
			First Visualization	Blank / Zero		✓		§ 4.11
			Common Selection	Negative / Positive		✓		§ 4.12
			Arrow Type	Fixed arrows / Scrolling arrows		✓		§ 4.13
			Enable AUX Signals	10 + 0 / 6 + 4		✓		§ 4.14
		Input filtering	0 ..... 20		✓		§ 4.15	
		Gong from Arrows	No / Yes		✓		§ 4.16	
		Screensaver timer	Disabled / 10-20 / 30-60 / 60-120	✓	✓	✓	§ 4.17	
		Graphic Options	Floor Symbols	Show / Hide	✓	✓	✓	§ 4.18
			Arrows	Show / Hide	✓	✓	✓	
			Floor Symbols with Signal	Show / Hide	✓	✓	✓	
			Arrows with Signals	Show / Hide	✓	✓	✓	
			Auto Centering	No / Yes	✓	✓	✓	
			Numbers alignment	Center / Left / Right	✓	✓	✓	
			Kerning	No / Yes	✓	✓	✓	
			Filter Blinking Signals	No / Yes	✓	✓	✓	
			Orientation	Landscape / Portrait	✓	✓	✓	
	S1-S4 inputs Configuration		Input S1 / S2 / S3 / S4	✓	✓	✓	§ 4.19	
	AUX Signals configuration		AUX Signal 1 / 2 / 3 / 4	✓	✓	✓	§ 4.20	
	Info Screen		On / Off	✓	✓	✓	§ 4.21	
	Info Screen Time	5s / 10s / 15s / 20s	✓	✓	✓	§ 4.22		
	Date & Time Settings	Time settings / Date settings	✓	✓	✓	§ 4.22		
		Reset All Settings		✓	✓	✓	§ 4.23	
	USB	Display -> USB / USB -> Display - Aggiornamento firmware / Firmware update -		✓	✓	✓	§ 4.24	
	?	DEMO mode	No / Yes	✓	✓	✓		
		Firmware Ver. / Config. Name / Debug Mode / Life Time (ad uso interno / internal use)		✓	✓	✓		
<b>PRG</b>	Floor Settings	Floor Image	Choose the Images	✓	✓	✓	§ 4.25	
		Floor Audio	No / Audio slot 0 / ... / slot 19	✓	✓	✓		
		Floor Symbols	Choose the Symbols		✓			

## 4.1 Regolare il volume • Adjusting audio level

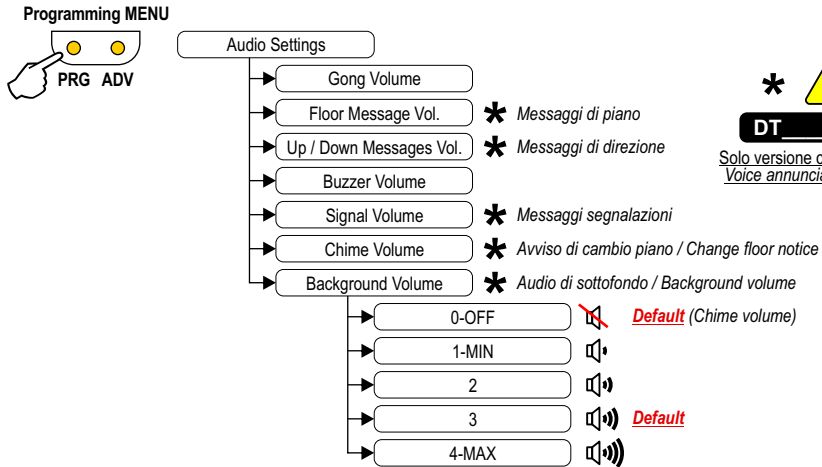

## 4.2 Impostare il ritardo di riproduzione dei messaggi audio Set up audio messages playback delay

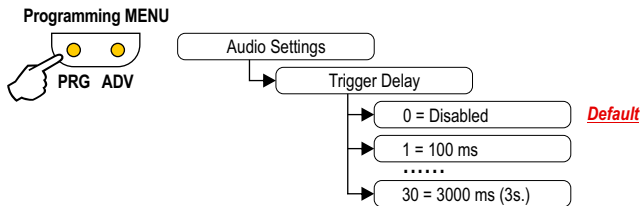

## 4.3 Impostare l'ordine di riproduzione dei messaggi audio Set up audio messages playback order

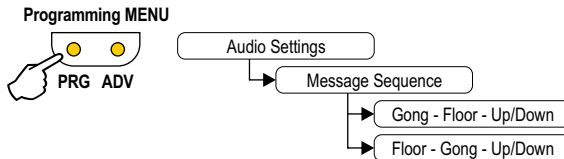

**!**  
DT \_\_\_\_ .DS  
Solo versione con sintesi vocale  
Voice announcator version only

## 4.4 Impostare Giotto come display di cabina o di piano Set up Giotto as car or floor indicator

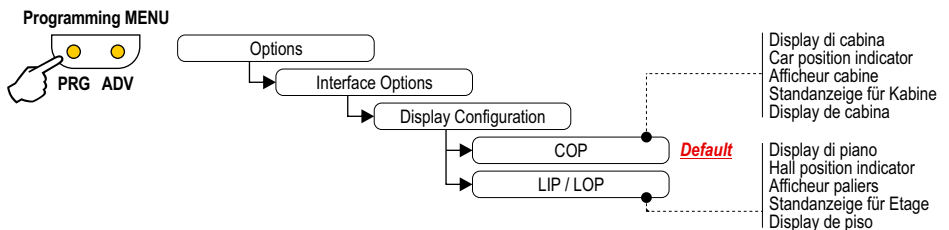

## 4.5 Configurare le frecce • Arrow setting up

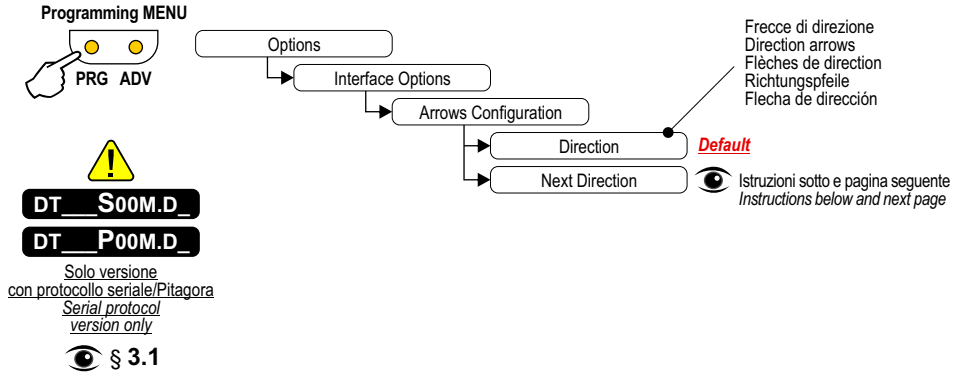

### Frecce di prossima direzione con segnale esterno Next Direction Arrows enabled from input • Flèches de prochaine direction par signal externe Nächst- Richtungs-Pfeile mit äußeren Signal • Flechas de próximo sentido

Il gong e le frecce si accendono solo sul display con l'ingresso "NEXT DIRECTION" alimentato.  
Gong and arrows only light up on position indicators if the "NEXT DIRECTION" terminal s supplied with power.  
Le gong et les flèches s'allument seulement sur l'indicateur avec l'entrée "NEXT DIRECTION" alimentée.  
Die Pfeilen und Gong leuchten nur auf Digitalanzeigen mit gespeisten "NEXT DIRECTION" Eingang.  
Las flechas y el gong sólo se encienden sobre el indicador con la entrada "NEXT DIRECTION" alimentada

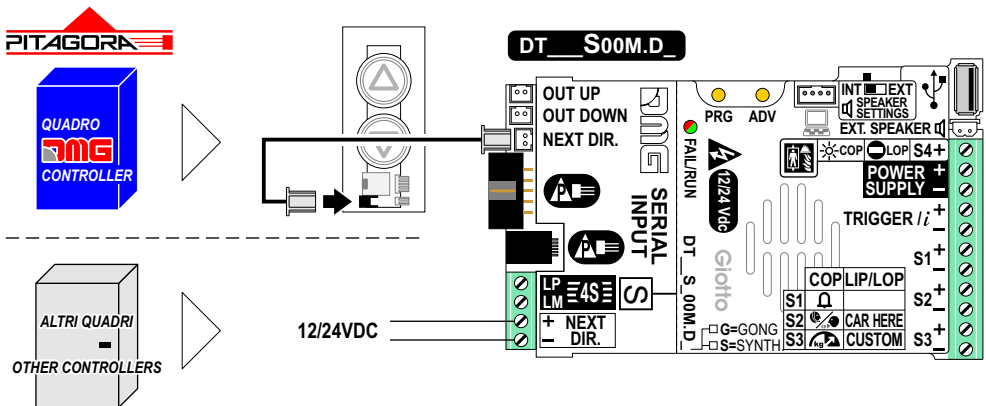

Se è utilizzato un Encoder DEUM, consultare il relativo manuale  
If the DEUM Encoder is used, please refer to the pertinent manual  
Si vous utilisez un encodeur DEUM, consultez la notice d'installation relative  
Wenn ein DEUM Encoder benutzt wird, bitte Installationsanleitung nachschlagen  
Si utilizado el codificador DEUM, consulten el manual de instrucciones.

## Frecce di prossima direzione autonome Next direction arrows locally programmed • Fèches de prochaine direction autonomes Autonome Nächst- Richtungs-Pfeile • Flechas de próximo sentido autónomas

Attraverso la **procedura di indirizzamento** è possibile assegnare stabilmente a ciascun display l'informazione del piano al quale è posizionato; in tal modo la freccia di prossima direzione compare solo al piano dove si ferma la cabina.

Through the **addressing procedure** one can permanently assign to each indicator the information of the floor on which it is mounted; in this way, next direction arrows only light up at the floor where the car is positioned.

Avec la **procédure d'adressage** il est possible d'assigner à chaque indicateur l'information de l'étage auquel il est monté; de cette manière, la flèche de prochaine direction apparaît seulement à l'étage auquel la cabine s'arrête.

Mittels der **Richtungs-Prozedur** kann man der Digitalanzeige Infos über dem Stockwerk zuweisen; in diesem Fall leuchtet der Nächst- Richtungs-Pfeil nur am Stockwerk wo den Fahrkorb sieht.

A través del **procedimiento de encaminamiento** es posible asignar establemente a todo indicador la información del piso al cual está situado; de esta manera la flecha de próximo sentido sólo aparece al piso donde se para la cabina.

Se è utilizzato un Encoder DEUM, consultare il relativo manuale  
If the DEUM Encoder is used, please refer to the pertinent manual  
Si vous utilisez un encodeur DEUM, consultez la notice d'installation relative  
Wenn ein DEUM Encoder benutzt wird, bitte Installationsanleitung nachschlagen  
Si utilizado el codificador DEUM, consulten el manual de instrucciones.

### Procedura di indirizzamento • Addressing procedure Procédure d'adressage • Richtungs- Prozedur • Procedimiento de direccionamiento



**A** Collegare tutti i display di piano all'ENCODER o al quadro PLAYBOARD  
Connect all position indicators to the ENCODER or PLAYBOARD controller  
Brancher tous les indicateurs paliers à l'encodeur ou à la manœuvre PLAYBOARD  
Alle Stockwerksdigitalanzeigen an ENCODER oder an der PLAYBOARD Steuerung anschließen  
Conectar todos los indicadores de piso al ENCODER o al cuadro PLAYBOARD

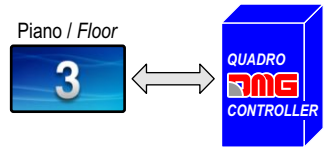

**B** Portare la cabina al piano relativo al display da indirizzare  
Position car on the floor of the Display which needs to be directed  
Arrêter la cabine à l'étage de l'indicateur à adresser  
Fahrkorb an den gleichen Stockwerk bremsen wo die zu richten Digitalanzeige liegt  
Llevar la cabina al piso relativo al indicador de direccionar

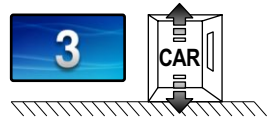

**C** Verificare che i caratteri/numeri/lettere visualizzati siano quelli desiderati  
Verify that the characters/numbers/letters visualized are the desired ones  
Vérifier que les caractères/numéros/lettres visualisés sont ceux que vous souhaitez  
Kontrollieren, dass die Ziffern / Buchstaben die gewählten sind  
Averiguar que los caracteres / números / letras visualizadas sean aquéllas deseadas



**D** Posizionare una calamita davanti al display e attendere che il display lampeggi 3 secondi per conferma  
Put a magnet in front of the indicator and wait for it to blink for 3 seconds for confirmation  
Mettre un aimant devant l'indicateur et attendre qu'il clignote 3 secondes pour confirmation  
Ein Magnet vor der Digitalanzeige legen und warten bis diese für 3 Sekunden blinkt und bestätigt  
Posicionar un imán delante del indicador y esperar que el indicador relampaguee para 3 segundos por confirmación

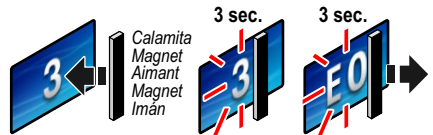

**E** Ripetere la procedura per ogni piano.  
Repeat procedure for each floor.  
Répéter la Procédure pour chaque Etage  
Für jede Haltestelle, die Prozedur wiederholen  
Repetir este proceso en cada piso

## 4.6 Abilitare la segnalazione "Presente" da ingresso "NEXT DIR." Enable "Car at Floor" signal from "NEXT DIR." input

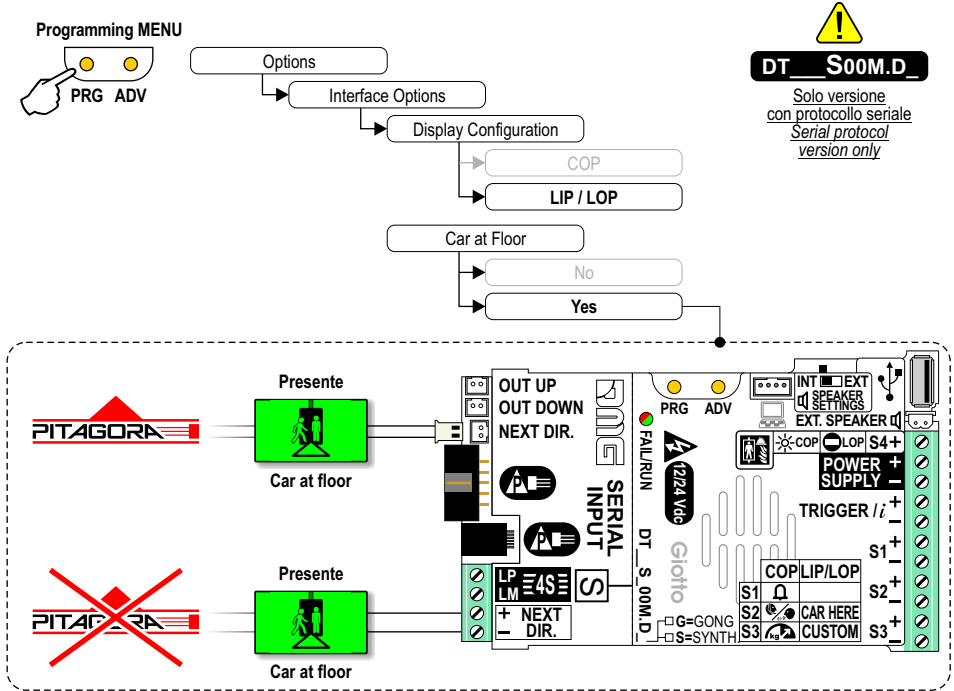

## 4.7 Impostare il gong indipendente dalla frecce Set up the gong to be independent from arrows

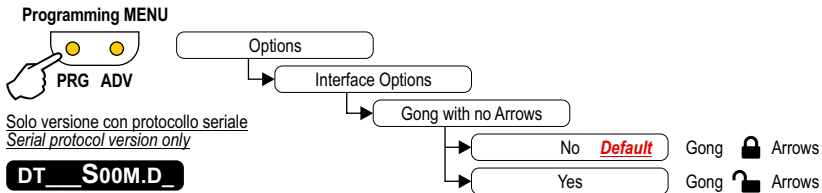

## 4.8 Impostare la velocità di trasmissione del protocollo CAN Set up CAN BUS protocol transmission speed

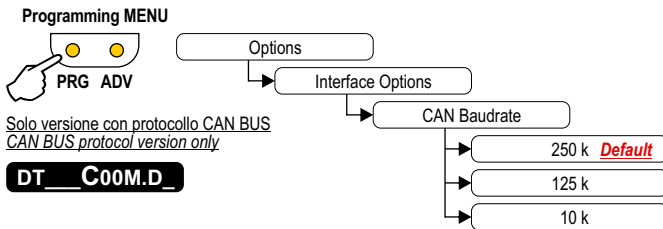



#### 4.9 Visualizzazione dei piani intermedi • Intermediate floors visualization

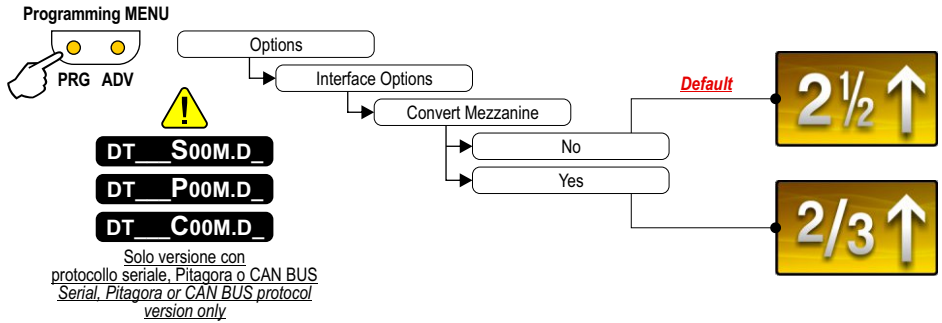

#### 4.10 Impostare l'OFFSET dei piani • Set up floors OFFSET

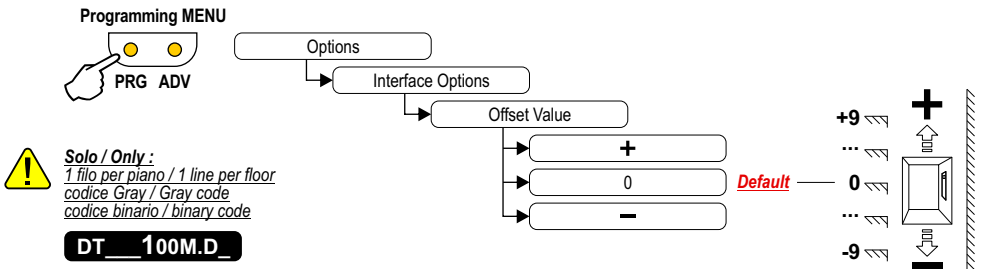

#### 4.11 Impostare la prima visualizzazione • Set up first visualization

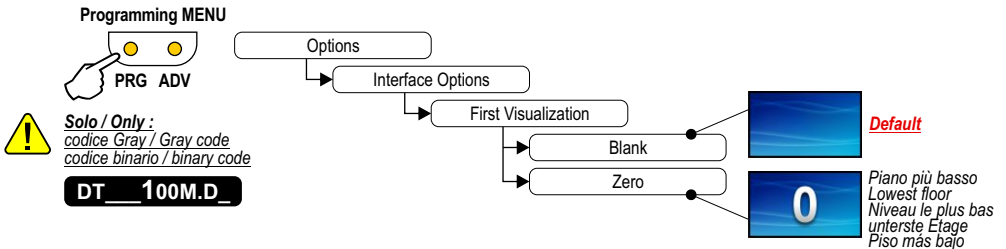

#### 4.12 Impostare il comune degli ingressi paralleli di posizione Set up Parallel position common input

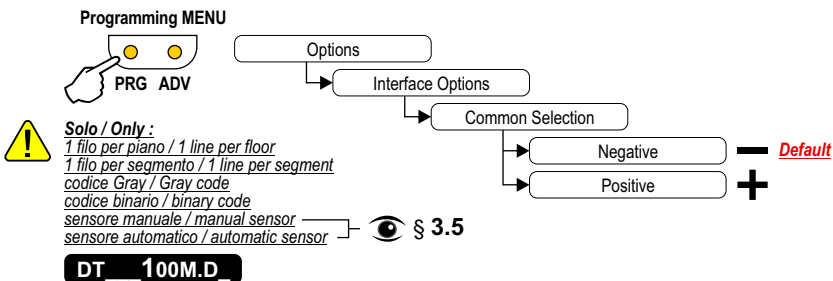

## 4.13 Impostare le frecce scrolling Set up scrolling arrows

Programming MENU

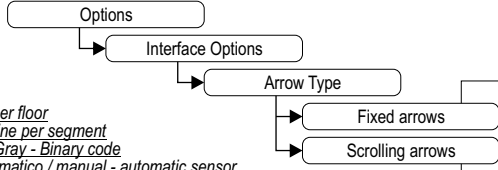

Default

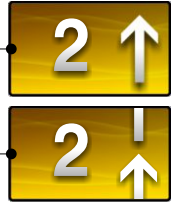

**Solo / Only :**  
 1 filo per piano / 1 line per floor  
 1 filo per segmento / 1 line per segment  
 codice Gray - Binario / Gray - Binary code  
 sensore manuale - automatico / manual - automatic sensor

**DT\_\_100M.D\_\_**

## 4.14 Abilitare le segnalazioni ausiliarie Enable auxiliary signals

Programming MENU

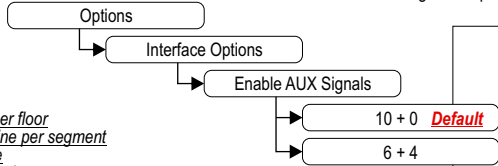

Ingressi di piano / Floor Inputs  
X01 + X10

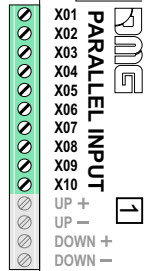

**Solo / Only :**  
 1 filo per piano / 1 line per floor  
 1 filo per segmento / 1 line per segment  
 codice Gray / Gray code  
 codice binario / binary code

**DT\_\_100M.D\_\_**

Ingressi di piano / Floor Inputs  
X01 + X06

Segnalazioni ausiliarie / AUX Signals  
X07 + X10

## 4.15 Impostare il ritardo di visualizzazione del cambio piano Set up the display delay of floor change

Programming MENU

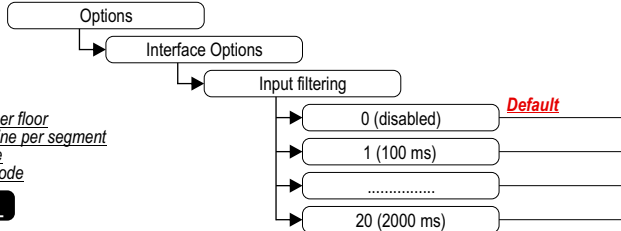

Default

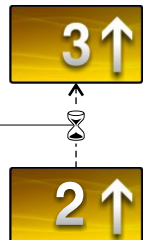

**Solo / Only :**  
 1 filo per piano / 1 line per floor  
 1 filo per segmento / 1 line per segment  
 codice Gray / Gray code  
 codice binario / binary code

**DT\_\_100M.D\_\_**

Il ritardo da impostare serve ad evitare eventuali errori di visualizzazione che possono verificarsi al cambio di piano.  
 The display delay helps avoiding visualization errors during floor change.  
 Le retard à prévoir dans les réglages sert à éviter toutes erreurs d'affichage qui peuvent se produire au changement d'étage.  
 Die eingestellte Verspätung, nutzt um Anzeigungsfehler zu vermeiden welche bei Etage-Änderung möglich sein könnten.  
 El retraso a ajustar es para evitar cualquier error de visualización que pueda ocurrir en el cambio de piso.

### 4.16 **Abilitare il Gong da ingresso frecce** **Enable Gong from arrow input**

Il comando gong viene gestito simultaneamente a quello delle frecce senza collegare i morsetti "trigger".  
The gong command is handled simultaneously with the arrows without connecting the "trigger" terminals.  
Le signal du gong fonctionne en parallèle avec celui des flèches sans brancher les bornes "trigger".  
Der Gong-Kommando wird gleichzeitig mit dem der Pfeile gehandhabt, ohne die "Trigger" Klemmen anzuschließen.  
El mando del Gong está gestionado simultáneamente con el de las flechas sin conectar los bornes de "trigger".

**Programming MENU**

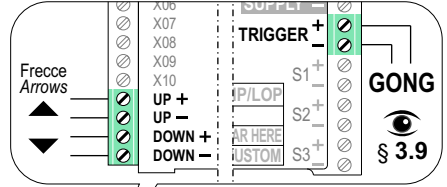
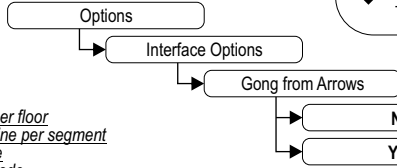

**Solo / Only :**  
1 filo per piano / 1 line per floor  
1 filo per segmento / 1 line per segment  
codice Gray / Gray code  
codice binario / binary code  
sensore manuale / manual sensor  
sensore automatico / automatic sensor

**DT\_ 100M.D\_**

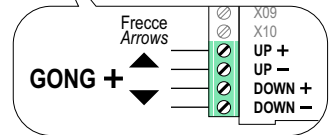

### 4.17 **Abilitare la funzione di risparmio energetico** **Enable energy saving function**

**Programming MENU**

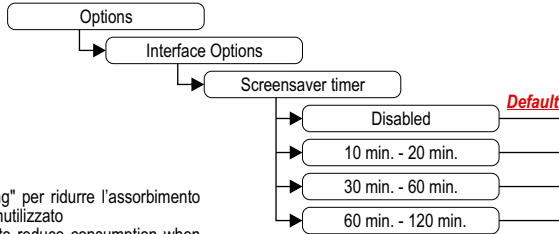

Funzione "energy saving" per ridurre l'assorbimento quando l'impianto è inutilizzato  
"Energy saving" mode to reduce consumption when idle  
Fonction "économie d'énergie" pour réduire l'absorption si l'ascenseur n'est pas utilisé  
"Sparfunktion" um Verbrauch während Nichtbenützung des Aufzuges zu verringern  
Función de "ahorro energético" para reducir la absorción cuando el ascensor está inactivo

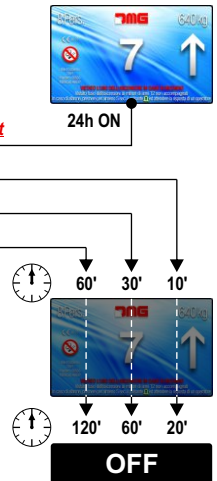

## 4.18 Scegliere le opzioni grafiche • Choose graphic options

Mostrare / Nascondere la posizione • Show / Hide position

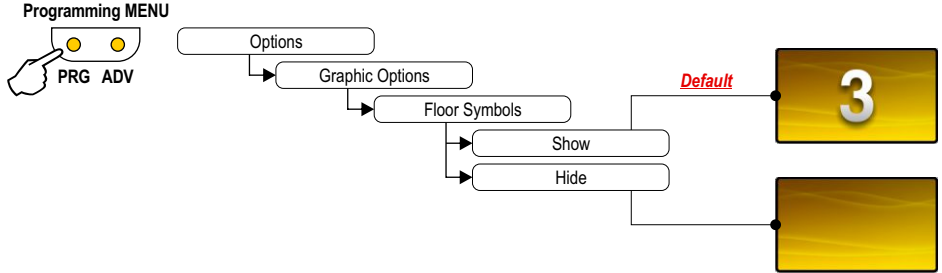

Mostrare / Nascondere le frecce • Show / Hide arrows

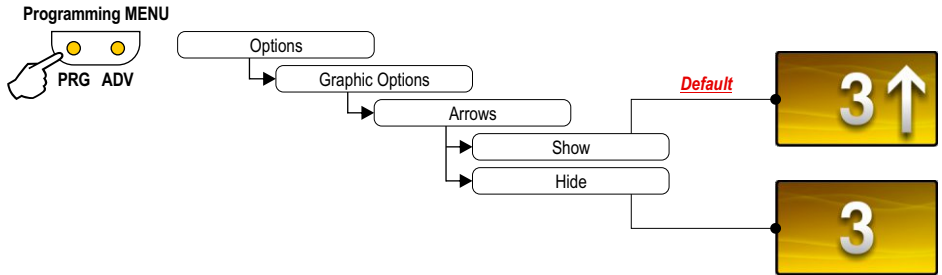

Mostrare / Nascondere la posizione con la segnalazione • Show / Hide position with Signal

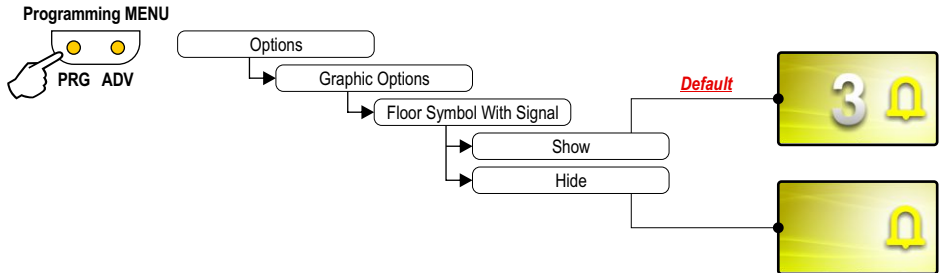

Mostrare / Nascondere le frecce con la segnalazione • Show / Hide arrows with Signal

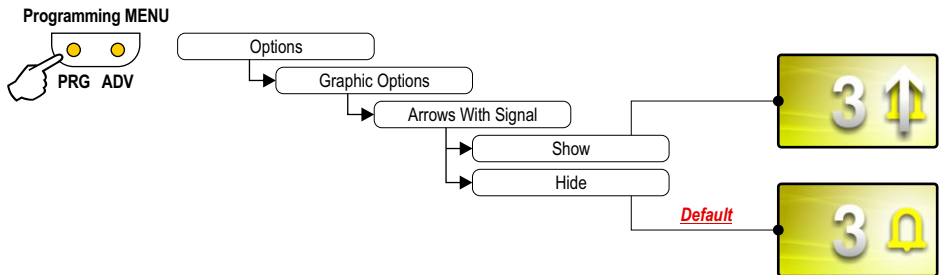

## Centraggio automatico • Auto Centering

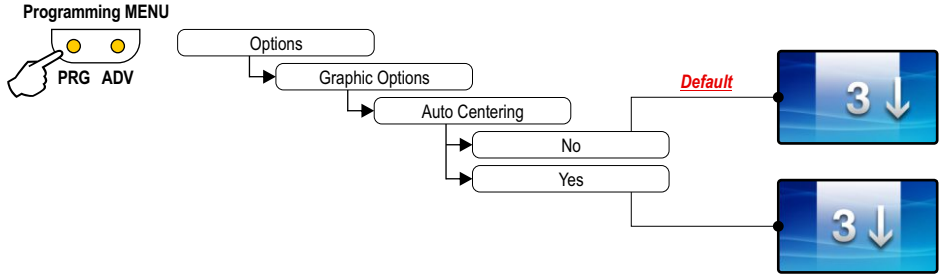

## Allineamento delle cifre • Numbers alignment

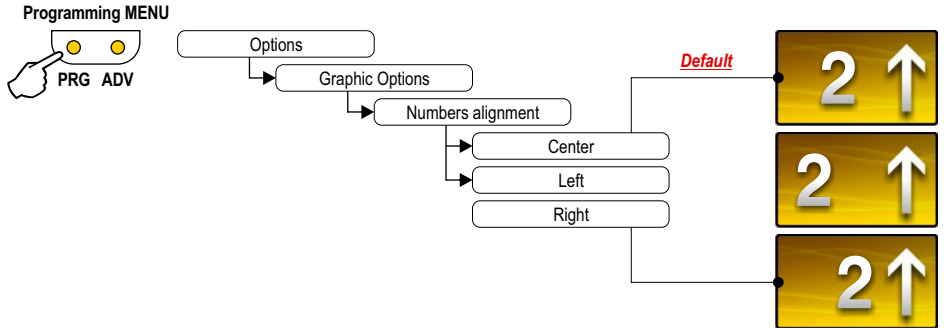

## Ridurre lo spazio tra i simboli • Reduce space between symbols (Kerning)

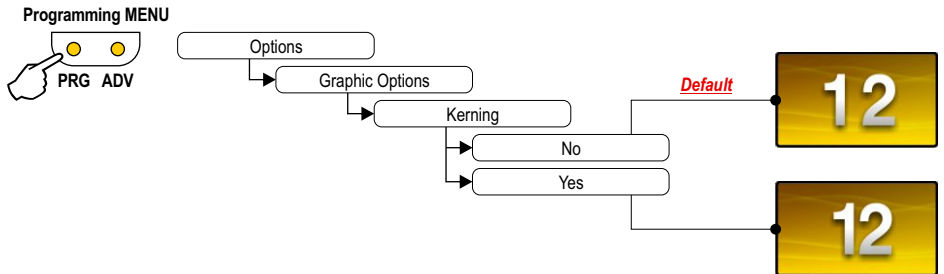

## Visualizzazione delle segnalazioni • Signals visualization

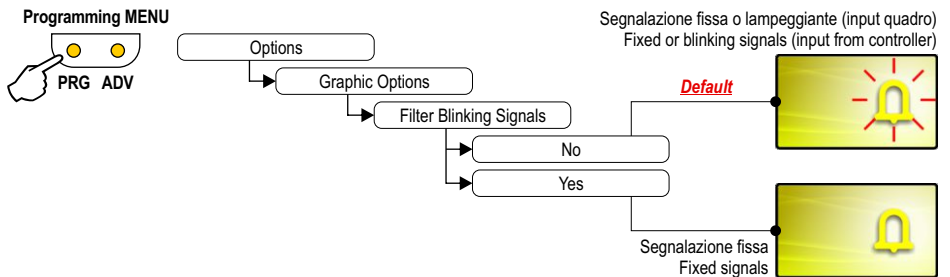

## Impostare l'orientamento display • Set up display orientation

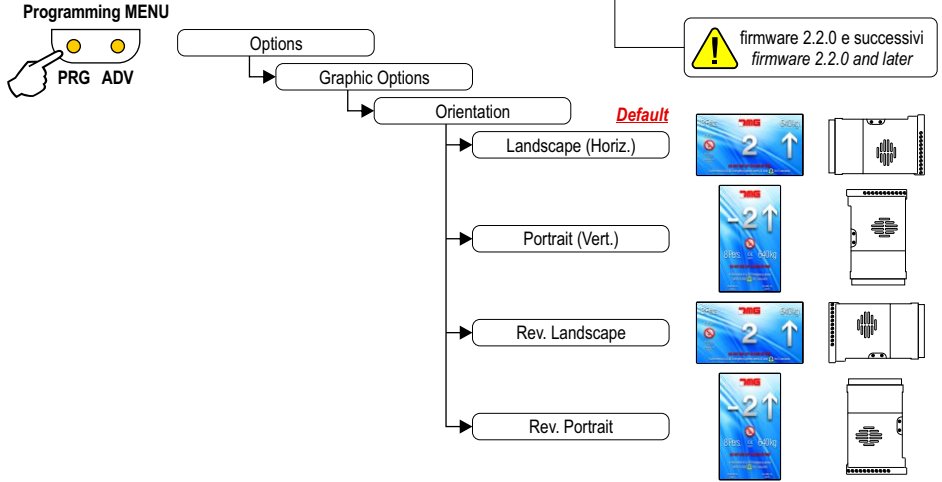

## 4.19 Configurare gli ingressi di servizio • Set up service message inputs

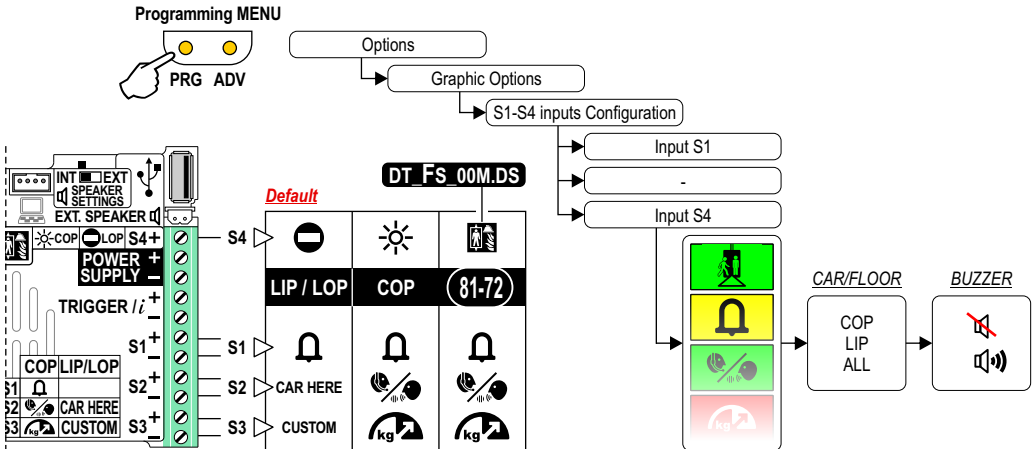

## 4.20 Configurare le segnalazioni ausiliarie • Set up auxiliary signals

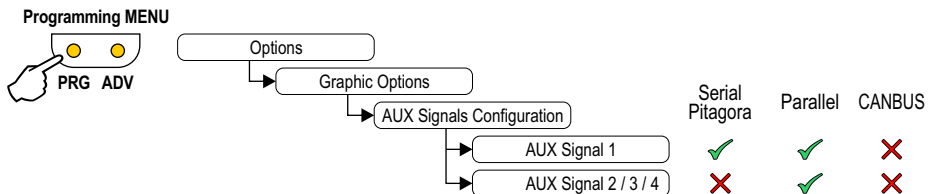

## 4.21 Configurare la funzione "INFO" • Set up "INFO" function

Le immagini "INFO" vanno caricate tramite PC software "Giotto Mosaic", vengono visualizzate con la pressione del pulsante (i) e rimangono attive per un periodo di tempo preimpostato (Info Screen Time).

"INFO" screens must be uploaded using "Mosaic" software, and are activated for 5 to 20 seconds by pressing the "INFO" button (i).

Les images "INFO" sont chargées avec le SW "Giotto Mosaic". Peuvent être visualisé en poussant sur le bouton (i) et restent actives pour une période programmé avant (Info Screen Time).

Die "INFO" Bilder müssen mittels „Giotto MOSAIC“ Software gespeichert werden. Diese werden durch drücken des (i) Tasters gezeigt, und bleiben für eine vorzeitig geregelte Zeit (Info Screen Time) aktiv.

Las imágenes "INFO" deben cargarse a través del software PC "Giotto Mosaic", se visualizan pulsando el botón (i) y permanecen activas durante un periodo de tiempo preestablecido (demora de salida automática).

### Programming MENU

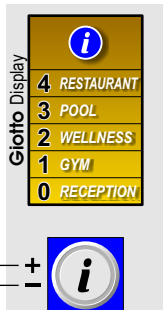
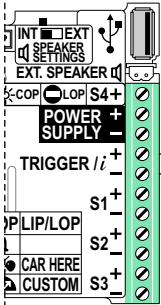
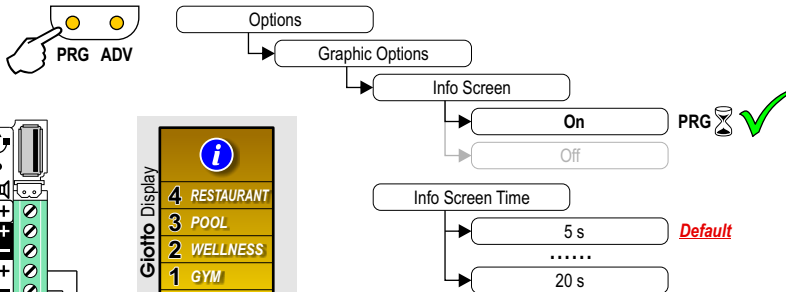

Utilizzando la funzione "INFO" non sarà possibile attivare localmente il trigger per la sintesi vocale.

Usage of the "INFO" function will disable local activation of vocal announcer's trigger.  
En utilisant la fonction "INFO" il ne sera pas possible d'activer localement le déclencheur pour la synthèse vocale.

Bei Benutzung der "INFO" Funktion, wird nicht mehr möglich sein das Trigger für den Sprachcomputer lokal zu aktivieren.

Utilizzando la función "INFO" no será posible activar localmente el trigger de la síntesis de voz.

## 4.22 Impostare Data ed Ora • Date and Time Settings

### Programming MENU

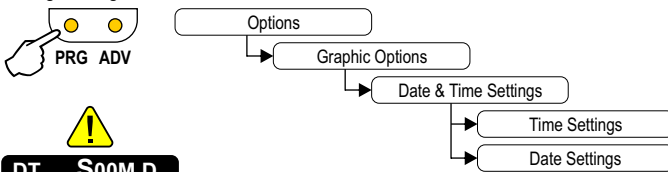

Solo versione con protocollo seriale, Pitagora o CAN BUS  
*Serial, Pitagora or CAN BUS protocol version only*

## 4.23 Ripristinare i settaggi di fabbrica • Restore the factory settings

### Programming MENU



Il display viene riportato alle impostazioni di fabbrica e le impostazioni personalizzate vengono eliminate.

The display original factory settings will be restored and configurations will be deleted.

Pour configurer de nouveau l'indicateur avec les paramètres usine; tous les paramètres personnalisés seront effacés.

Die Anzeige wird mit Werk-Standard-einstellungen konfiguriert. Alle benutzerdefinierten Einstellungen werden gelöscht.

El display vuelve a la configuración de fábrica y las configuraciones personalizadas se eliminan.

## 4.24 Esportare / importare dati • Data export / import

**A**

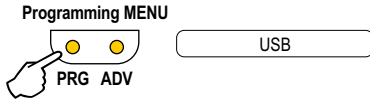

**B**

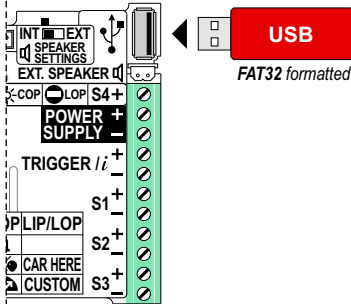

\* Verranno esportate solo le configurazioni originariamente create con il software MOSAIC, non le modifiche fatte sul display. Only the settings initially configured through MOSAIC software will be exported. Modifications made on the display will not be exported.

Seulement les configurations créés à l'origine avec le logiciel de MOSAIC seront exportés, aucun changement effectuée avec l'afficheur

Es werden nur die ursprünglichen Konfigurationen, welche mit dem Software MOSAIC erstellt wurden exportiert, nicht die Änderungen, welche auf dem Display vorgenommen wurden.

Sólo se exportarán las configuraciones creadas inicialmente con el software MOSAIC, no los cambios realizados en la pantalla.

**C**

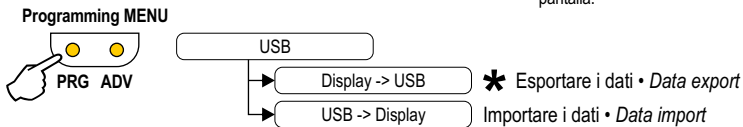

## - Aggiornare il firmware • Firmware update -

**A**

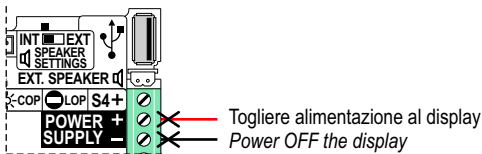

**B**

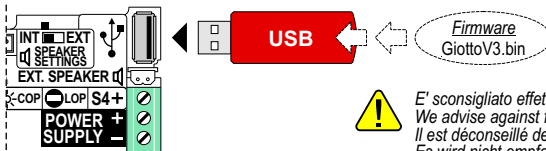

**C**

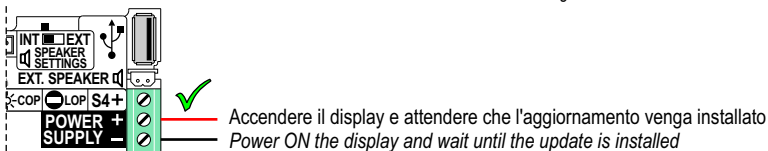



**4.25** Personalizzazioni di piano • *Floor customizations*

**A**

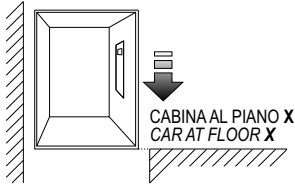

**B**

**Configurare le immagini di piano • Set up floor background images**

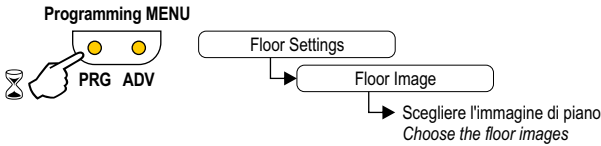

**!** L'immagine deve essere prima importata tramite software "Mosaic".  
*Images must be previously imported by "Mosaic" software.*

**C**

**Configurare i messaggi piano • Set up floor message**

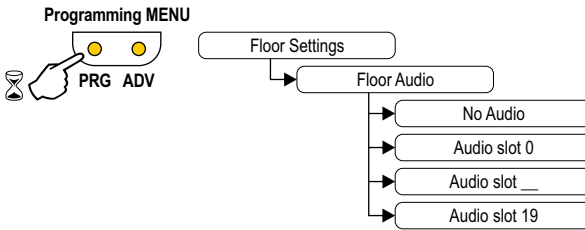

**!** Solo versione con sintesi vocale  
*Voice annunciator version only*

**DT\_\_\_\_\_DS**

**D**

**Configurare i simboli piano • Set up floor symbols**

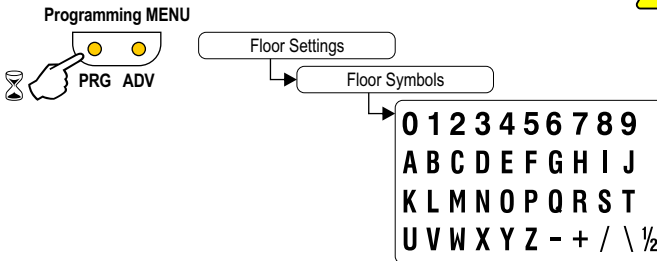

**!** **Solo / Only :**  
*1 filo per piano / 1 line per floor*  
*1 filo per segmento / 1 line per segment*  
*codice Gray / Gray code*  
*codice binario / binary code*  
*sensore manuale / manual sensor*  
*sensore automatico / automatic sensor*

**DT\_\_100M.D**

**MESSAGGI DI SERVIZIO**  
**SERVICE MESSAGES**

 configurazione di **CABINA**  
**CAR configuration**

 configurazione di **PIANO**  
**FLOOR configuration**

SEGNALAZIONI / INDICATORS / VOYANTS / ANZEIGEN / PILOTOS		configurazione di <b>CABINA</b> <b>CAR configuration</b>	configurazione di <b>PIANO</b> <b>FLOOR configuration</b>
Allarme inviato Alarm sent Alarme envoyée Notanfrage gesendet Alarmá enviada		M 4S	
Comunicazione stabilita Communication established Communication établie Alarm empfangen Comunicación establecida		M 4S	
Sovraccarico Overload Surcharge Überlast Sobrecarga		M 4S	
Manovra di emergenza Emergency operation Dispositif de secours Automatische Stockwer. Maniobra de emergencia		4S	4S
Manovra pompieri Lift on fire service Manœuvre pompiers Brandfall Maniobra bomberos	EN 81-72 DT_FS_00M.DS	M 4S	MOSAIC
Priorità cabina Reservation Priorité cabine Vorzug Prioridad		MOSAIC	4S
Fuori servizio Out of service Hors service Ausser betrieb Fuera de servicio		MOSAIC	M
Presente Car here Present Hier Está			M
Allarme (legge 13)			M 4S
Luce antipanico Anti-panic light / Eclairage anti-panique Anti Panik Beleuchtung / Luz de cortesia		M (NO EN 81-72)	
Dati impianto Installation data / données installation Aufzugsdaten / datos de la instalación			
* Sintesi vocale Voice annunciator / Synthèse vocale Sprachcomputer / Sintetizador vocal		DT _____ DS	
GONG			

- M** Segnalazione a bordo display di default attivabile da morsetti (M) e/o da seriale (4S)  
 Default on board indicator activated by screw terminals (M) and/or serial line (4S)
- 4S** Intègré dans l'afficheur par default, contrôle par bornes (M) et/ou serielle (4S)  
 Integriert in der Anzeige, wird über Schraubklemmen (M) u./o. serielle Linie (4S) gesteuert  
 Los pilotos predefinidos del display se activan por bornes tornillos (M) y / o en serie (4S)
- MOSAIC** Segnalazione opzionale attivabile solo da sw mosaic  
 Optional indicator selectable only through "Mosaic" software  
 Option, voyant activable seulement par software "Mosaic"  
 Option, Lampe kann nur über die "Mosaic" Software eingestellt werden  
 Los pilotos opcionales se activan sólo con el sw "Mosaic"
- Messaggio audio a bordo display di default  
 Audio message on board by default  
 Message audio intégré dans l'afficheur par default  
 Audio-Meldung in der Standardausführung integriert  
 Mensaje de voz en el display predefinidos
- Messaggio audio opzionale attivabile solo da sw mosaic  
 Optional audio message selectable only through "Mosaic" software  
 Option, activable seulement par software "Mosaic"  
 Option, kann nur über die "Mosaic" Software eingestellt werden  
 Mensaje de voz opcionales sólo se activan con el SW "Mosaic"

- \* — 20 messaggi di piano (floor -3 + 16) + 2 di direzione (up/down) + max. 10 di servizio (signal)  
 20 floor messages (floor -3 + 16) + 2 direction (up/down) + 10 service max (signal)  
 20 énoncés de niveau (floor -3 + 16) + 2 de direction (up/down) + max. 10 de service (signal)  
 20 Etagen (floor -3 + 16) + 2 Meldungen von FK-Richtung (up/down) + max. 10 Dienst (signal)  
 20 piso (floor -3 + 16) + 2 de direccion (up/down) + max. 10 de servicio (signal)

**5 CARATTERISTICHE TECNICHE • TECHNICAL FEATURES**  
 CARACTERISTIQUES TECHNIQUES • TECHNISCHE DATEN • CARACTERISTICAS TECNICAS

<b>Dimensioni / Dimensions</b> <b>Abmessungen / Dimensiones</b>	4,3" (132x80 mm) / 4,3" EN 81-71 (138x100xh26 mm) 5,6" (132x129,5 mm) 7" (177,8x144 mm) / 7" EN 81-71 (198x165xh26 mm)
<b>Schermo / Screen</b> <b>Ecran / Abdeckung / Pantalla</b>	TFT 4,3": 98,7X57,2 mm / 480x272 pixel • 65.000 colors TFT 5,6": 115,3X87,1 mm / 640x480 pixel • 65.000 colors TFT 7": 155X94 mm / 800x480 pixel • 65.000 colors
<b>Alimentazione (ingressi di posizione)</b> <b>Power supply (position input)</b> <b>Alimentation (entrées de position)</b> <b>Speisung (Positionseingänge)</b> <b>Alimentación (entradas de posición)</b>	12+24V DC ±10%
<b>Assorbimento / Absorption</b> <b>Stromaufnahme / Absorción</b>	DISPLAY 12Vdc: Max 91mA (4,3"), Max 270mA (5,6"), Max 230mA (7") 24Vdc: Max 66mA (4,3"), Max 150mA (5,6"), Max 134mA (7") LUCE ANTIPANICO / ANTI-PANIC LIGHT 12Vdc: Max 80mA (4,3"), Max 242mA (5,6"), Max 210mA (7") 24Vdc: Max 44mA (4,3"), Max 125mA (5,6"), Max 110mA (7")
<b>Luminosità / Brightness</b> <b>Luminosité / Beleuchtung / Luminosidad</b>	LUCE ANTIPANICO / ANTI-PANIC LIGHT 
<b>Ingressi segnalazioni / Indicators inputs</b> <b>Entrées voyants / Eingänge Anzeigen</b> <b>Entradas pilotos</b>	S1 / S2 / S3: 12+24V DC ±10% (optoisolato / opto-isolated / optoisolé / Optokoppler / optoaisladas) Impedenza / impedance / impédance / Impedanz / impedancia = 3Kohm
<b>Temperatura di esercizio</b> <b>Operating temperature</b> <b>Température de fonctionnement</b> <b>betriebswarm</b> <b>Temperatura de funcionamiento</b>	-10°C ÷ +50°C (4,3"/5,6") -20°C ÷ +50°C (7")



**DMG SpA**

*Via delle Monachelle, 84/C  
00071 POMEZIA (ROMA) • ITALIA  
Tel. +39 06930251 • Fax +39 0693025240  
info@dmg.it • www.dmg.it*

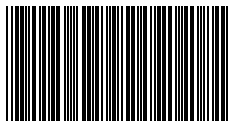

93010233