

**elevator  
touchscreen  
systems**  
product catalog





FIREFIGHTERS  
OPERATION

12:44 PM

# 9 NORTHERN HEIGHTS



UPH	
12	LPH
10	11
8	9
6	7
4	5
2	3
★ G	GR
P2	P1

TOUCH SCREEN TO SELECT YOUR FLOOR



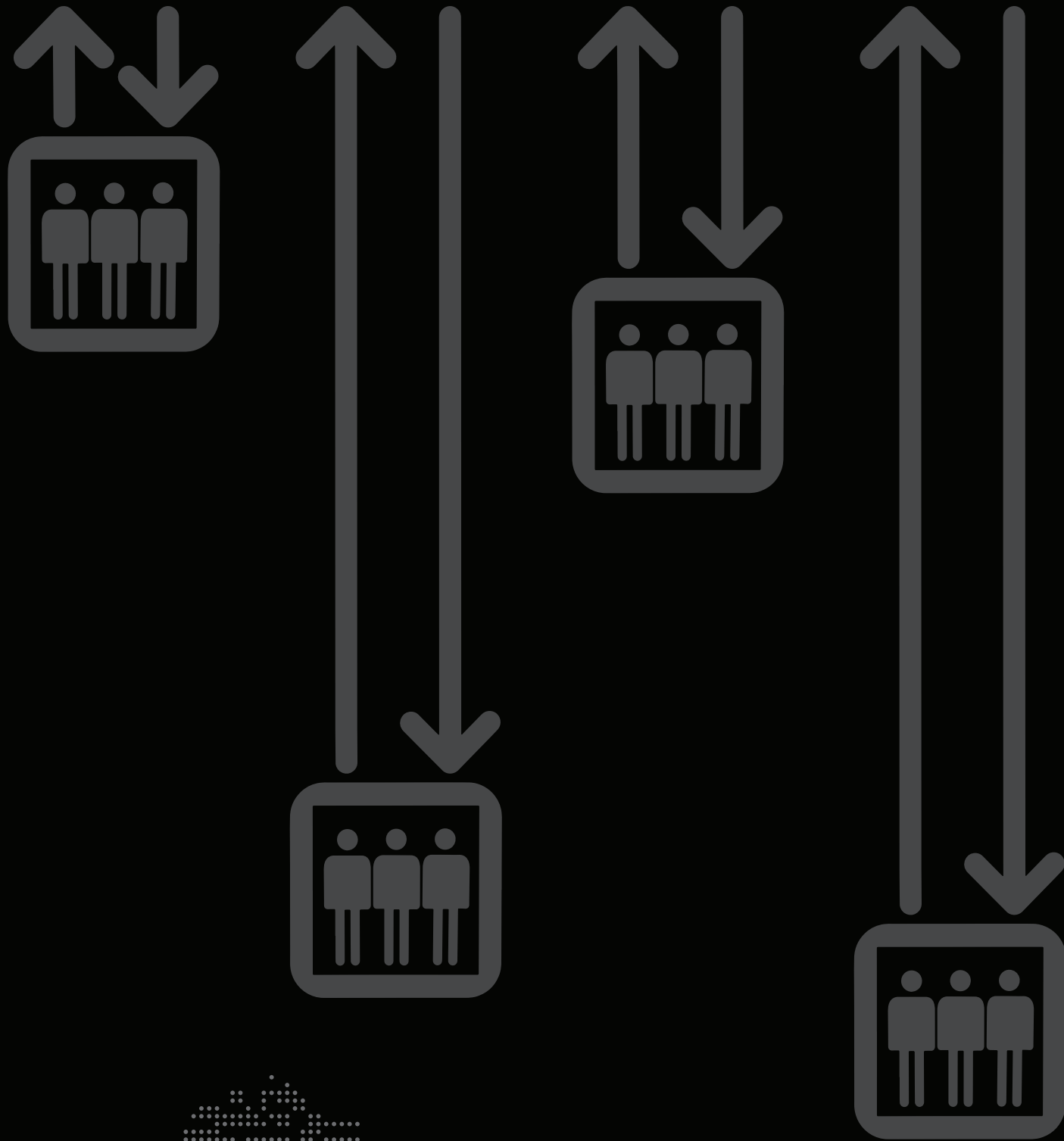

# ELEVATOR TOUCHSCREEN SYSTEMS PRODUCT CATALOG

CONTENTS

- 06 Overview
- 08 Graphics
- 24 Managing Content
- 26 Component Layout
- 31 Code Compliance
- 36 Specifications
- 37 Approvals



Founded in 2005, Touch-To-Go Technologies is the leader in elevator touchscreen systems. Our products have been sold to projects located throughout North America and internationally.

# OVERVIEW

Elevators are one of the most frequently used common areas of a building. For 15 years, the Touch-To-Go elevator touchscreen system has improved the passenger experience.

The Touch-To-Go (TTG) elevator touchscreen system takes the place of conventional pushbuttons and transforms user-elevator interaction into a dynamic, visual experience. The touchscreen graphics interactively change upon touch-request.

The TTG system connects the same way as conventional pushbuttons, allowing maximum flexibility for fixture upgrades, full modernizations or new construction. It is compatible with any elevator controller.



Brand your elevator with logos, graphics & videos



Display advertisements and promote on-site events, restaurants or amenities



Change screen themes for holidays & occasions



Code Blue, Fire Service, and other emergency services available



Easy-to-clean surface with any glass-approved solution



Operated by finger-touch and with a gloved or covered hand

## TOUCHSCREEN

ADA / Appendix E / Barrier Free compliance is achieved through either a keypad or redundant pushbuttons.

Emergency controls, door open, door close, etc. are still implemented with conventional pushbuttons; the touchscreen only supports selection of the destination floor.

The TTG system is made with a color LCD screen with an integrated touch-sensitive glass panel and a watertight bezel.

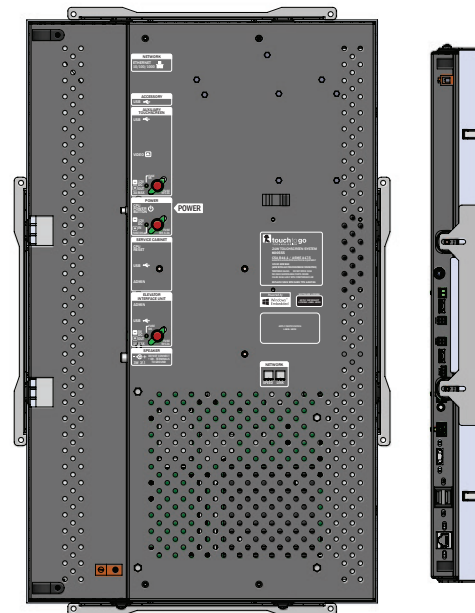

## SPECIFICATIONS



	15"	21"
<b>Viewable Area</b>	7.62"w x 13.55"h	10.6"w x 18.8"h
<b>Overall Dimensions (with Mounting Bracket)</b>	9.88"w x 15.75"h x 1.7"d	13"w x 21.05"h x 2.21"d
<b>Resolution (px)</b>	1080w x 1920h (Full HD)	1080w x 1920h (Full HD)
<b>Glass Type</b>	Tempered 6mm flush-mount glass	Tempered 3mm
<b>Viewing Angle</b>	Extra Wide (178°) LED	Extra Wide (178°) LED

## TYPICAL INSTALLATION

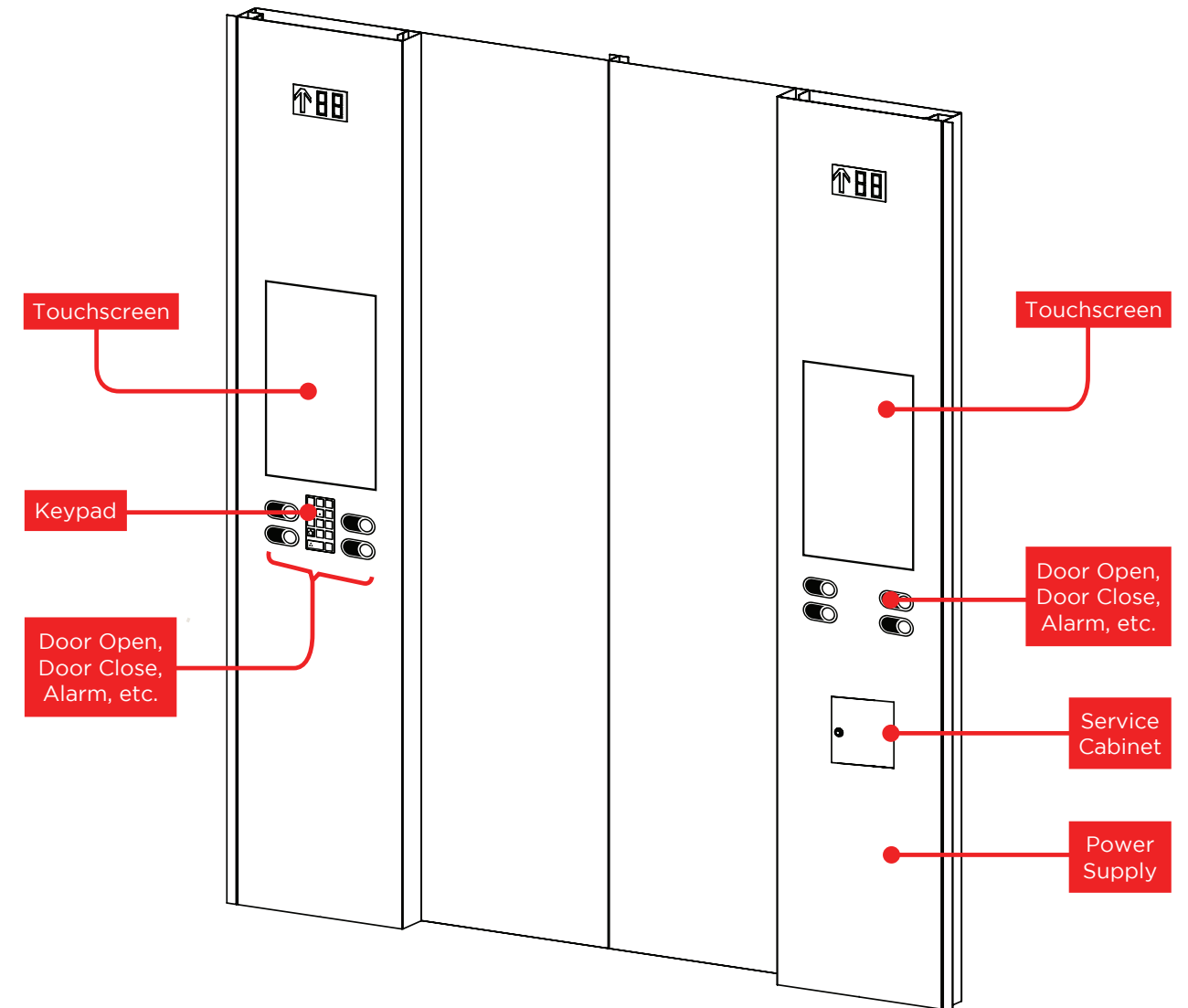

Typical installation in an elevator with center opening doors and dual swing-return COPs shown above.

# RESIDENTIAL

Custom graphics and themes are created specifically for each project, showcasing the building's branding and style while helping passengers reach their destination.

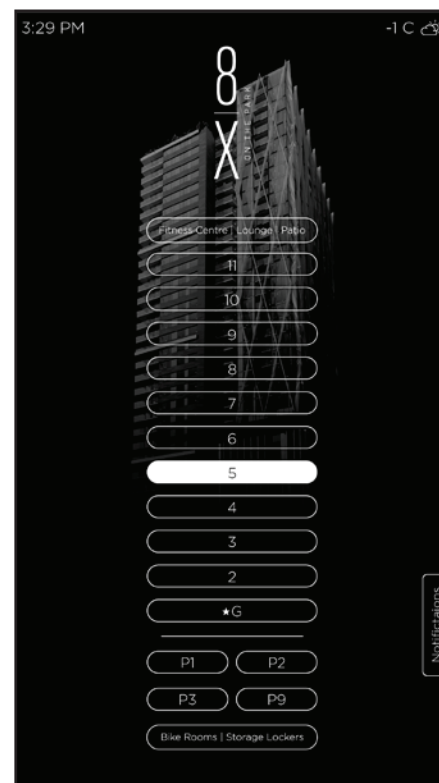
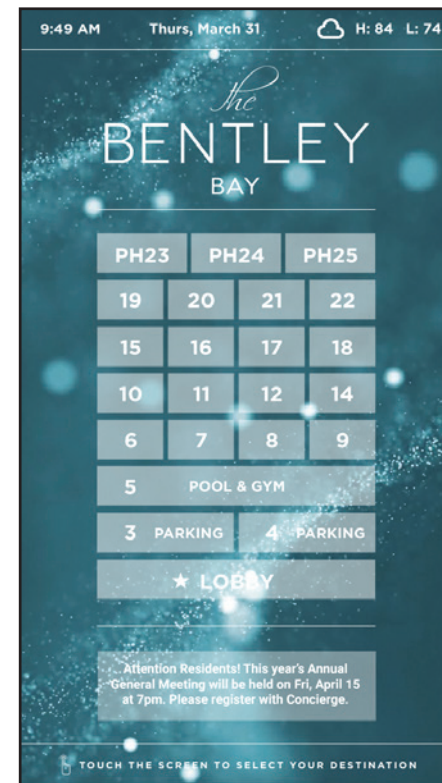

## KEY FEATURES

- Architectural renderings can be incorporated into theme graphics to help visualize the floor destination, while reinforcing status associated with higher floors.
- On-site amenities can be promoted from within the elevator such as pool or gym.
- Screens provide relevant information to tenants such as time, weather, announcements, or building events (User-defined Areas). Update and schedule from anywhere with an Internet connection.
- Two-way video system allows for passengers to communicate with Concierge/Security via video call in the event of an emergency. Recommended for buildings with hearing or speech impaired residents (additional feature).
- Advanced attendant service gives remote elevator control to the Concierge/Security desk. After the visitor is authorized and in the elevator, the Concierge/Security can dispatch the elevator to the desired floors (additional feature).

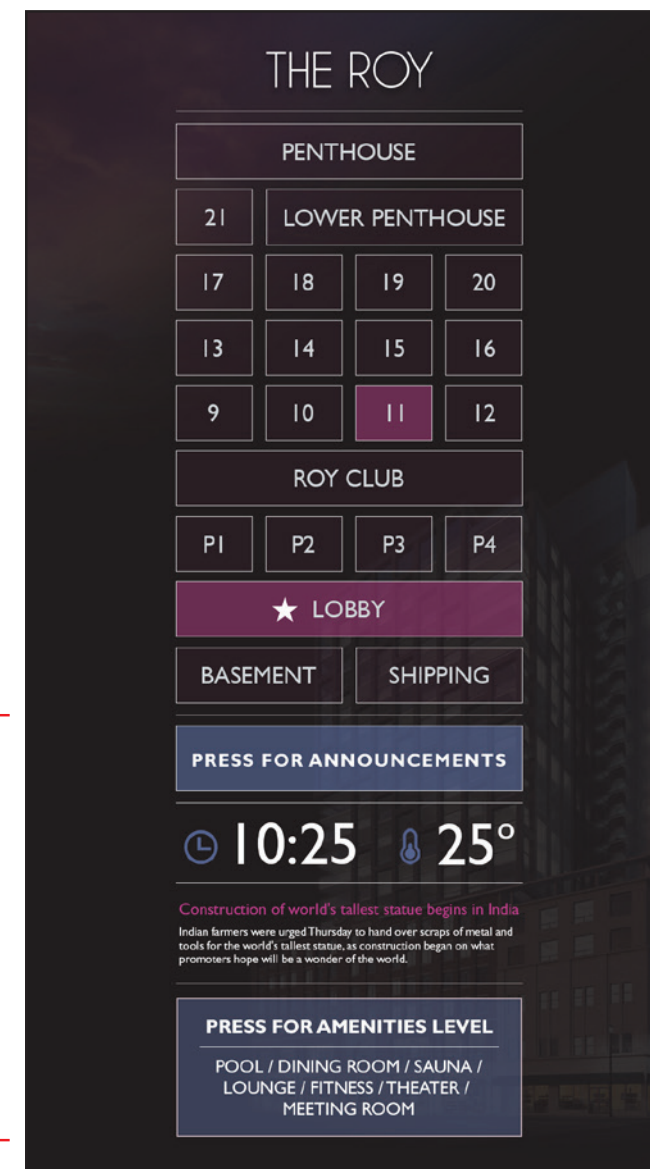

User-defined Areas

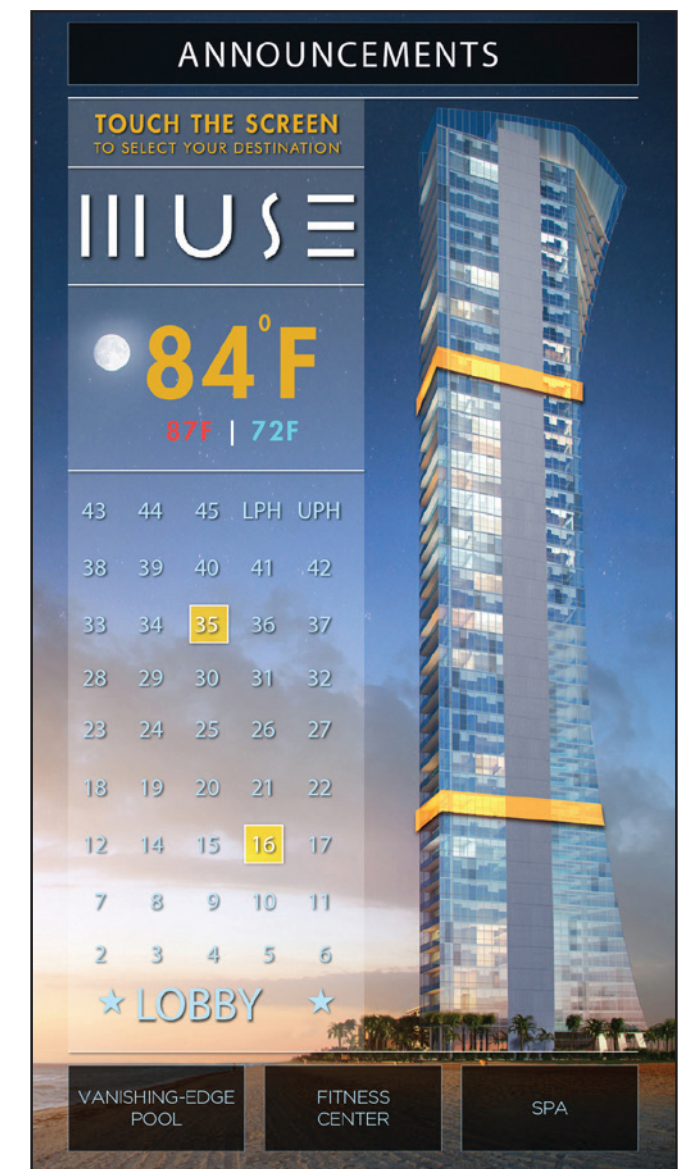

# HOSPITAL

Colorful, high-contrast graphics and large touch areas make the screen easy-to-read and use in a variety of passengers, including in multi-lingual facilities.

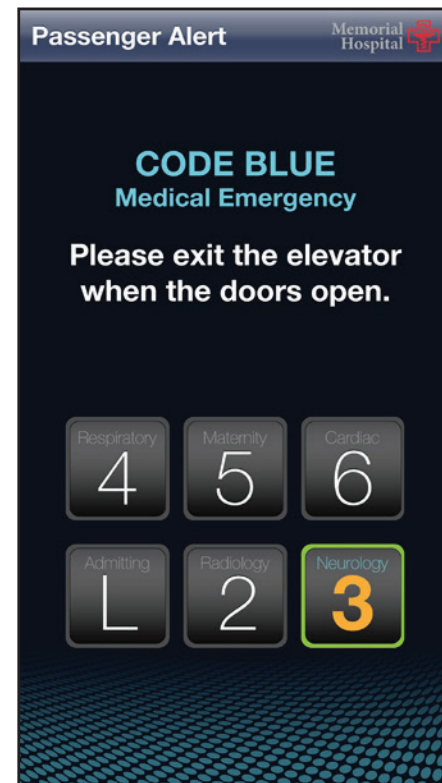
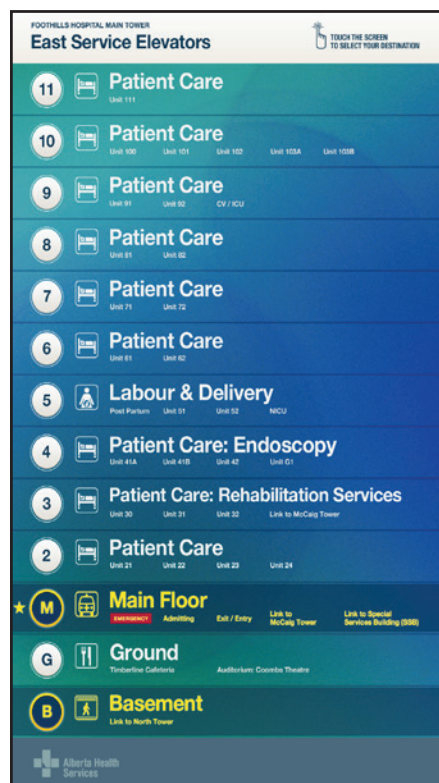
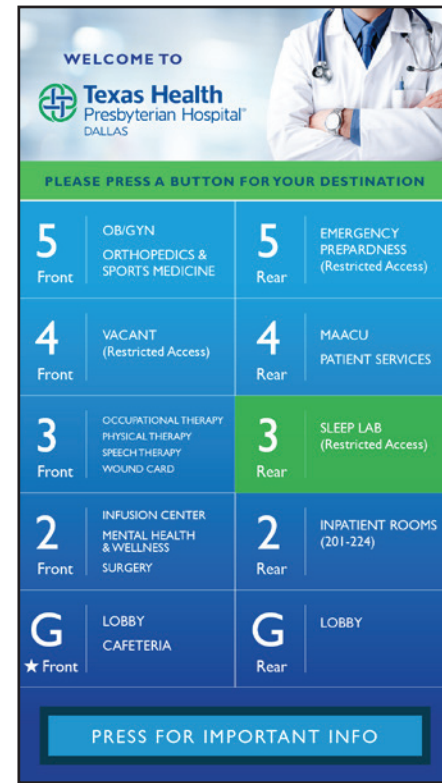
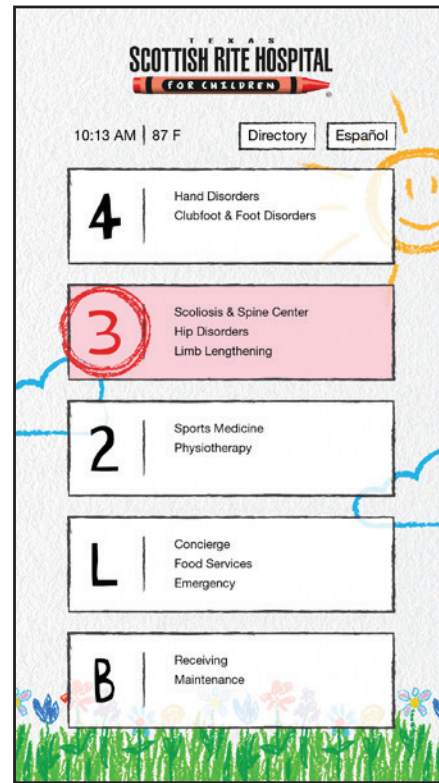

## KEY FEATURES

- The smooth glass surface is easy-to-clean with any glass-approved solution.
- Unlike mechanical pushbuttons, contaminants will not get trapped. A liquid tight bezel prevents accidental entry of fluid into electronics.
- Calls can be placed by finger-touch, or with a gloved/covered hand which helps prevent the transfer of germs.
- Floors requiring special access will appear hidden or faded, and cannot be selected until access is granted from the access card reader.
- When Medical Emergency (such as Code Blue) is activated, graphics automatically change to a simplified layout, including instructions for passengers. Floor numbers will still be present, allowing medical personnel to select the required floor once activated by a key switch or card reader.
- Themes can be customized for specific clientele of the building, such as a Children's Hospital.
- Directories allows passengers to interactively search for their physician.



# HOTELS

Touchscreens eliminate the need for engraved inserts or plaques on the car operating panels. Graphics can be changed as needed for special events or promotions.

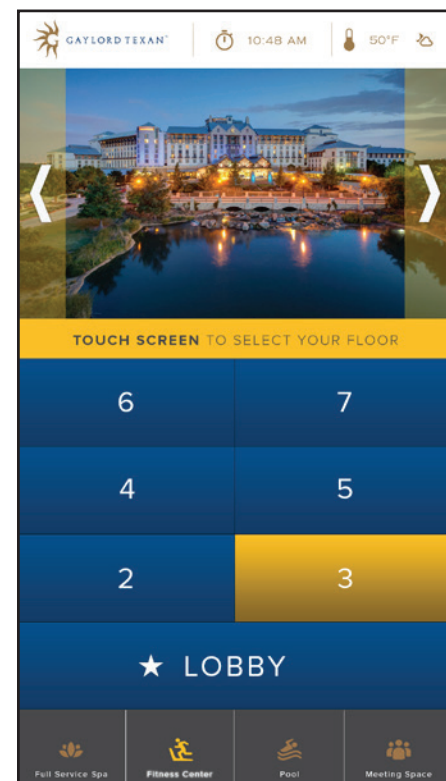
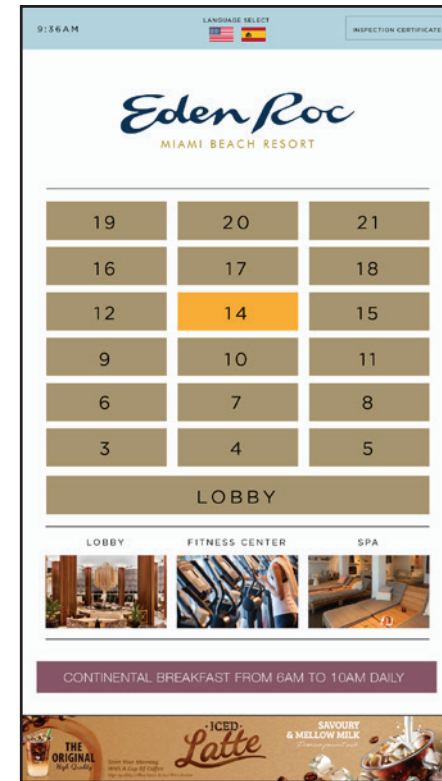
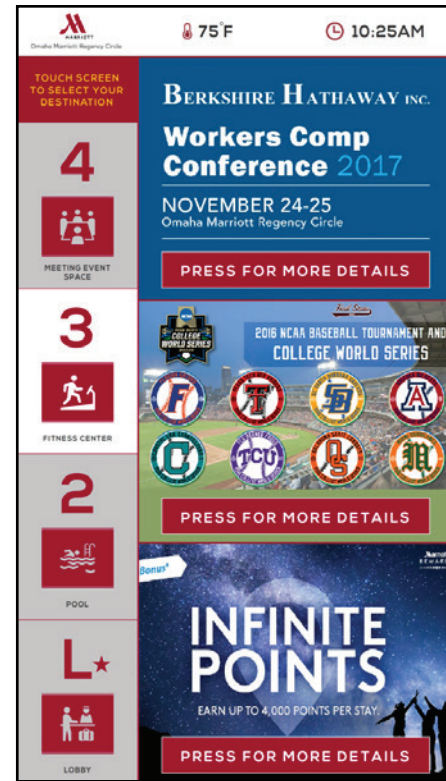

## KEY BENEFITS

- Seamlessly brand the elevator interior to match your building's identity through colors and customized themes.
- Highlight building features and amenities such as pool, spa, casino, or restaurants with pictures and video showcasing services (User-defined Area). Schedule and update from anywhere with an Internet connection.
- Inform guests of upcoming special events and promotions.
- Schedule different themes and content depending on the time of day, month or year.
- Interactive informational pop-ups can offer more details to items of interest.
- Wayfinding feature introduces information about the building's layout and helps guests figure out their path once they exit the elevator.
- Vandal resistant design for high traffic use.

User-defined Area



# CORPORATE & COMMERCIAL

Providing tenant names and descriptions makes navigating for visitors easier, while also promoting tenant corporate identity.

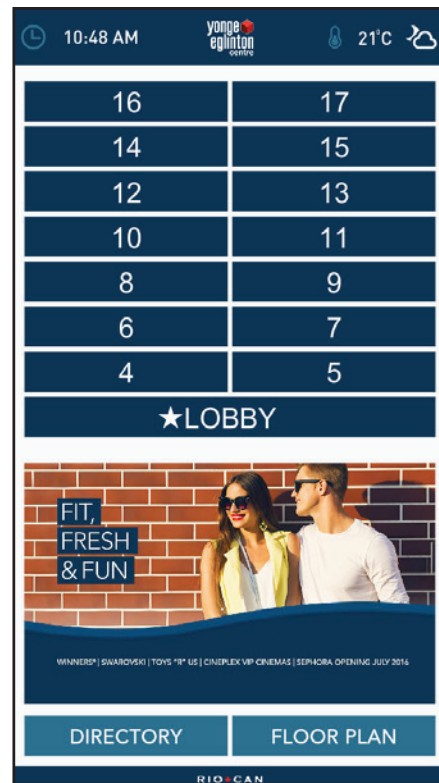

## KEY BENEFITS

- Promote tenant corporate branding.
- Extend design elements from the property to inside the elevator.
- Descriptions provides visitors assurance that they're headed to the correct floor.
- Display advertisements or information on events (User-defined Area). Update and schedule from anywhere with an Internet connection.
- Interactive informational pop-ups can offer more details to items of interest.
- Wayfinding feature introduces information about the building's layout and helps guests figure out their path once they exit the elevator.
- Vandal resistant design for high traffic use.

User-defined Area

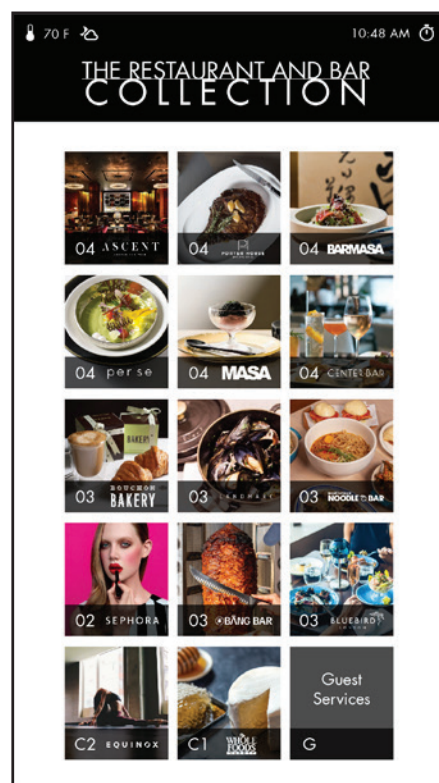
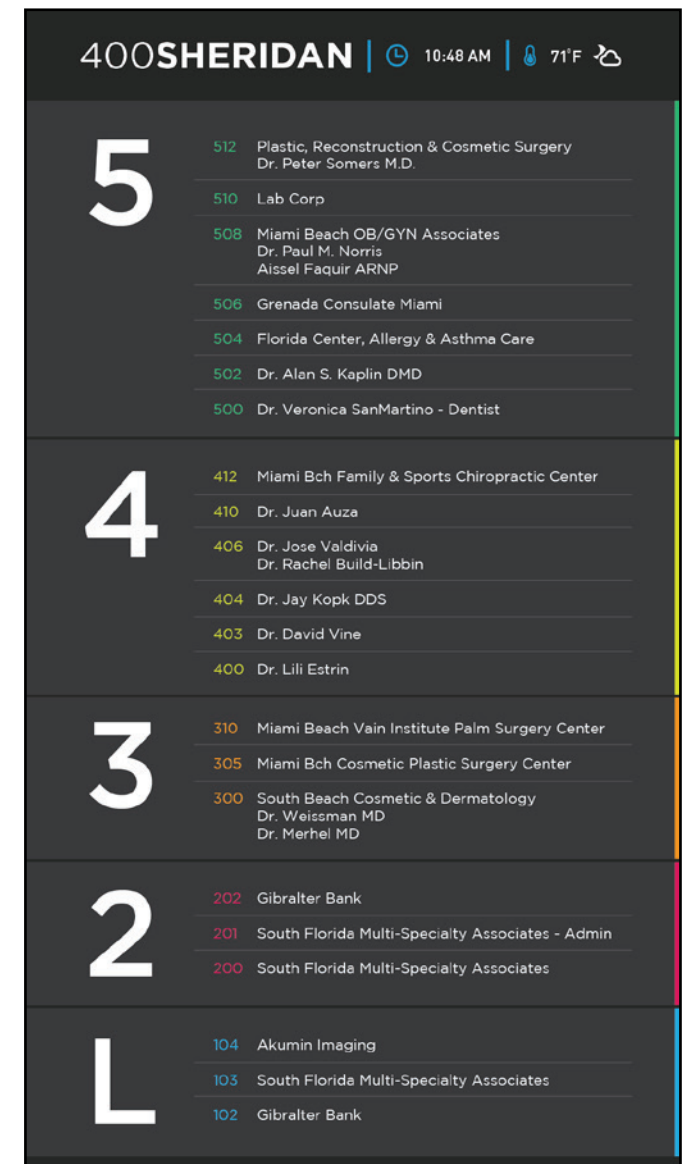



# INSTITUTIONS

Live feeds and rotating graphics keeps students informed of upcoming events, campus closures, and other relevant information.

**CAROLINA** STADIUM MAP  
82°F 12:48 PM

- MEZZANINE BOX
- POPE BOX
- 200 LEVEL SEATS
- GROUND LEVEL

**UPCOMING GAMES**

June 9 4 pm	June 16 3 pm	June 19 Noon	June 20 4 pm
----------------	-----------------	-----------------	-----------------

**Manhattan School of Music**

Auditorium  
Street Level

10:48 AM 50°F

**UHealth** UNIVERSITY OF MIAMI MILLER SCHOOL of MEDICINE

PH	Patient Care: Rehabilitation Services
12	Patient Care: Endoscopy
11	Emergency Preparedness (Restricted Access)
10	Orthopedics & Sports Medicine
9	OB / GYN
8	Patient Services
7	Speech Therapy   Wound Care
6	Occupational Therapy   Physical Therapy
5	Sleep Lab (Restricted Access)
4	Surgery
3	Inpatient Rooms (201-224)
L	Infusion Center   Mental Health & Wellness
★ 1	Exit   Registration Desk   Cafeteria

TOUCH SCREEN TO SELECT YOUR FLOOR

## KEY BENEFITS

- Keep students up-to-date on Sports functions.
- Link Twitter and RSS feeds for live campus updates.
- Interactive informational pop-ups can offer more details to items of interest.
- Campus maps helps visitors and new students find their classroom.
- Change screen themes for holidays or campus events.
- Vandal resistant design for high traffic use.
- Active Shooter, Emergency Broadcast, and other security features available.

UNIVERSITY OF NOTRE DAME  
Hesburgh Libraries

VIEW BY  
**FLOOR** CALL NUMBER

14	President's Lounge
13	Philosophy   Psychology   Religion
12	Theology   Subject Librarian Offices
11	Theology   History General Europe Russia
10	History Africa the Americas Asia
9	Literatures British American Germanic
8	Political Science   Law   Education Literatures Classical Celtic Slavic Middle Eastern Asian
7	Medieval Institute
6	University Archives
5	Romance Literatures
4	Technical Services Offices
2	Economics   Business   Music Art   Photography   Current Periodicals Classrooms 201c 222 222A 247 248   University Librarian's Suite
1	Center for Digital Scholarship   Circulation   Computer Cluster Ask Us Help Desk   Interlibrary Loan   Reference Collection Rare Books & Special Collections   Au Bon Pain Café
LL	Geography   Anthropology   Sports   Sociology STEM Collections   Military Sciences   Bibliography Government Documents   Media & Reserves Desk   Microforms

Monday, May 24 11:47 am library.nd.edu

TEAM NEWS STADIUM MAP  
82°F 12:48 PM

- MEZZANINE BOX
- 300 LEVEL SEATS
- 200 LEVEL SEATS
- GROUND LEVEL

**UPCOMING GAMES**

Sept 1 4 pm	Sept 8 3 pm	Sept 15 Noon	Sept 21 4 pm
----------------	----------------	-----------------	-----------------

**ACADEMY of ART UNIVERSITY**

4 5  
2 3  
Ground

Directory

Campus Events

**Sheridan**

4 Faculty Offices Study Rooms FLOOR MAP

3 Library Student Centre FLOOR MAP

2 Library Student Centre FLOOR MAP

1 Registration Office Cafeteria / Food Court Bus Loop FLOOR MAP

BLOWN AWAY  
NETFLIX | JULY 12

**Seminole**

6 University Center Club Osceola Grille  
University Center Club Private Meeting Rooms  
Pensack Boardroom | Bough Faculty Room | East & West Terraces

5 University Center Club Private Meeting Rooms  
Medium Room | Pensacola Room | Gaines Room | University Room

4 University Center Club Offices  
Dedman School of Hospitality Admin Offices  
InPI Center for Hospitality Research & Dev.

3 University Center Club Grand Ballroom

2 Hospitality Academic Advising  
Dedman School of Hospitality Distance Learning Program

1 Seminole Sports Shop  
FSU Visitor Center

GAME INFORMATION TO GO HERE PRESS FOR MORE

# AIRPORT

Touchscreen graphics can match icons, colors and typefaces used on building signage for a stress-free and seamless visitor experience.

## KEY BENEFITS

- Multiple language selections can be programmed, making the system easy to use for international visitors.
- Interactive maps to help visitors navigate once they exit the elevator.
- Link Twitter and RSS feeds for live airport updates.
- Create ad space for on-site businesses and services (ex. Park N'Fly).
- Familiar icons and large touch-sensitive areas make the system easy to use.
- Vandal resistant design for high traffic use.

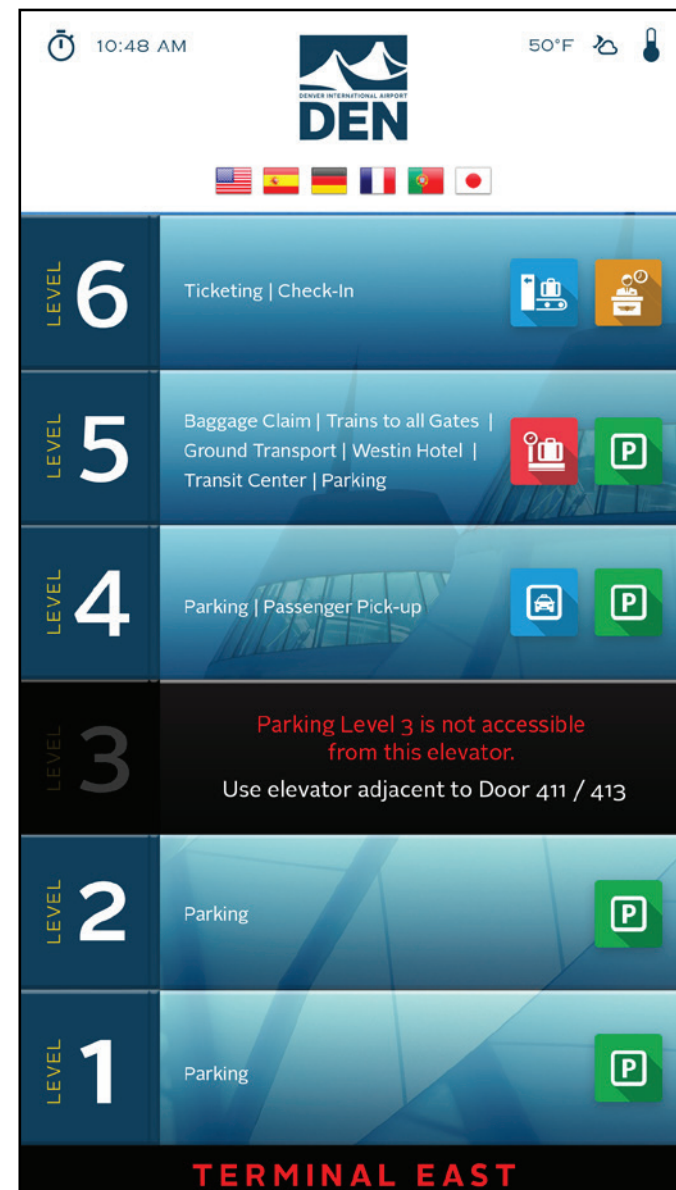

# WAYFINDING

The touchscreen graphics can incorporate interactive maps of the facility. Passengers can orient themselves and determine where to go once they exit the elevator.

## KEY BENEFITS

- Maps can be unique to each elevator, showing only relevant information.
- Touchscreens can match colors, typefaces and icons used on building signage for a stress-free and seamless visitor experience.
- Anchor store logos and tenant listings can be shown for improved orientation and branding in retail applications.
- Maps can be made interactive to only display upon user request, allowing for other information to be displayed when the map is not required.

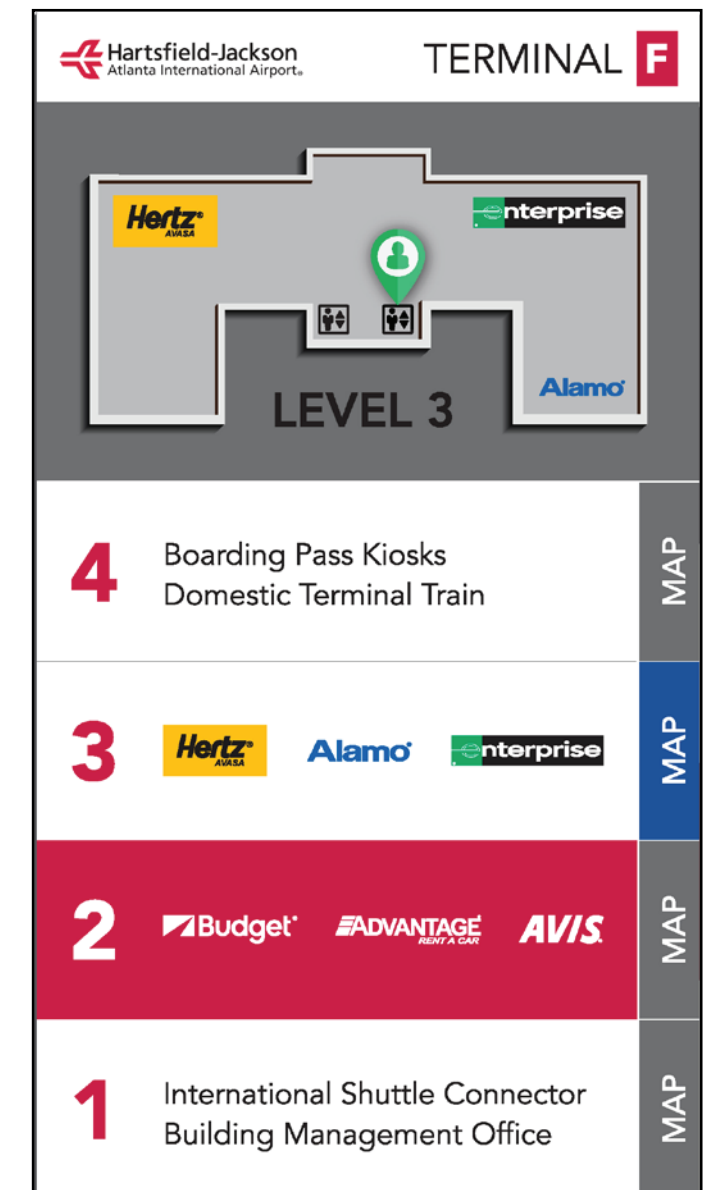
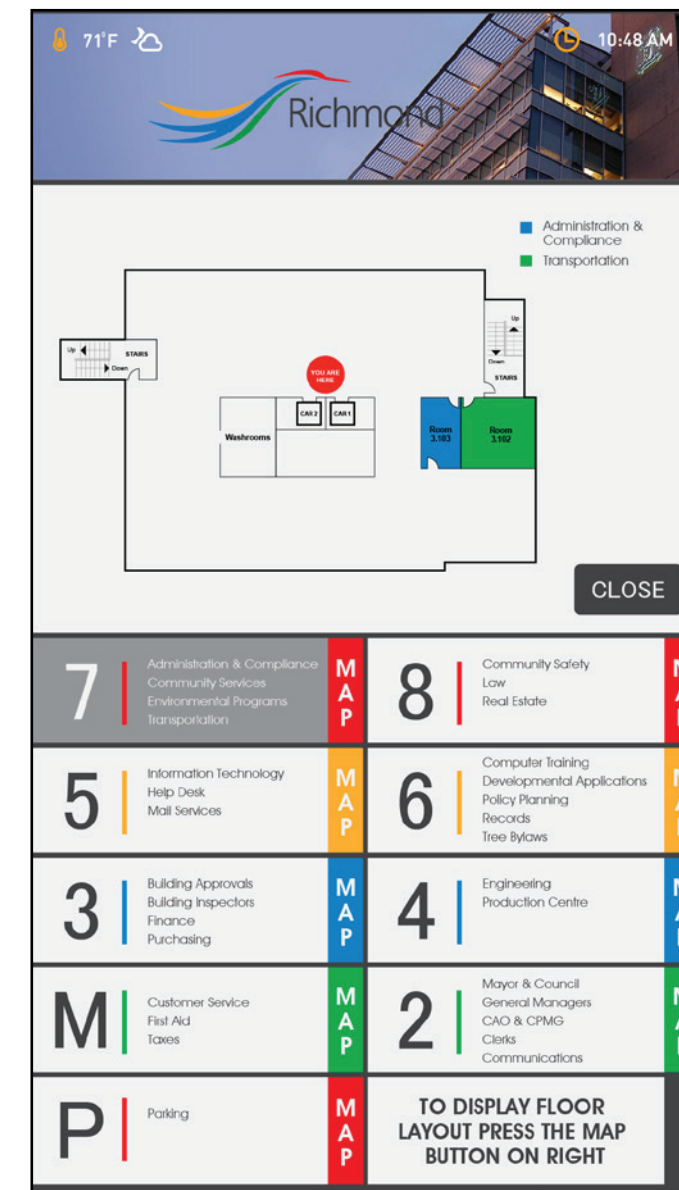

# FIRE SERVICE

Because the Touch-To-Go touchscreen system only replaces the call buttons, fire operation remains unchanged.

## KEY BENEFITS

- Can be operated with a covered or gloved hand.
- Simplified graphics with large touch areas designed specifically for Fire Service mode.
- Touchscreens can be configured to display floor maps of each destination floor once the Fire Service phase I key switch has been activated. This can aid emergency responders in navigating the building.
- Cannot be activated by heat
- In-car monitor such as the Matisse Position Indicator can display a video feed of the destination floor, allowing for assessment of the situation prior to opening the car doors (additional feature).

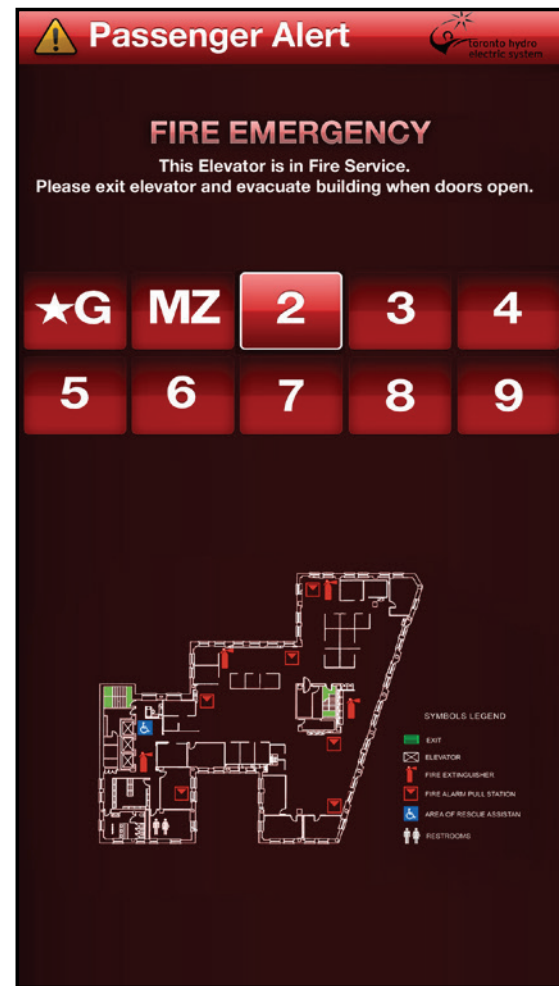
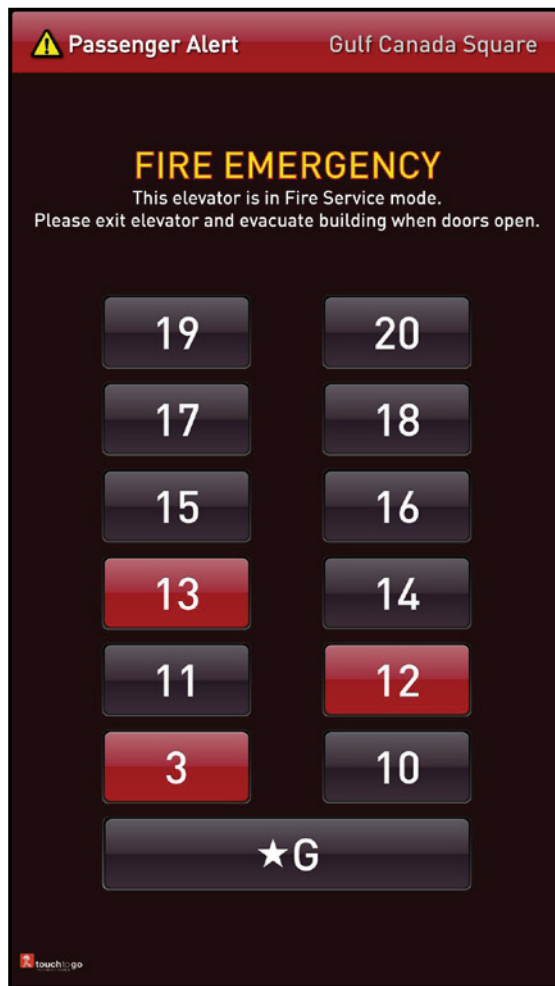

# SWING CARS

In cars that serve high-rise and low-rise floors, the touchscreens offer the ability to limit the floors served by the elevator.

The pushbutton graphics change using a keyswitch in the service cabinet, provides the ability to switch the car between low and high rise operation. In independent service or at activation of phase 1 fire service, graphics change to allow access to all floors served.

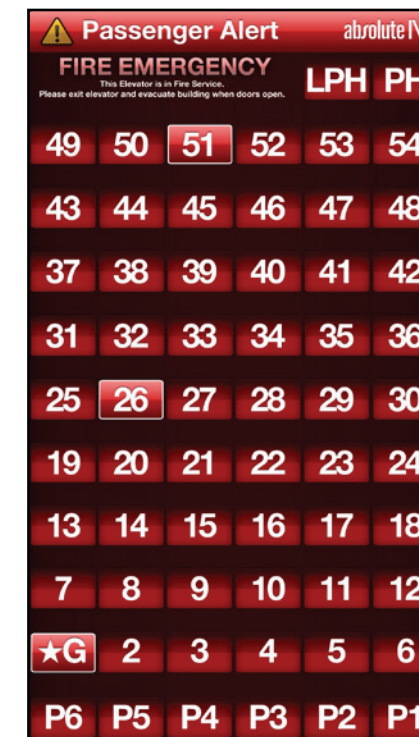
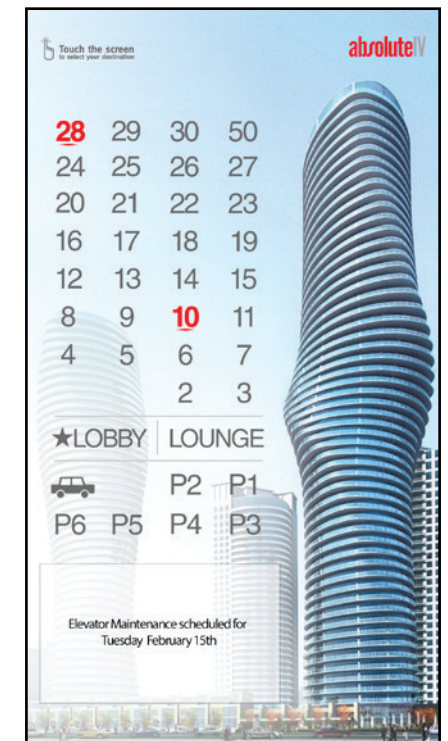
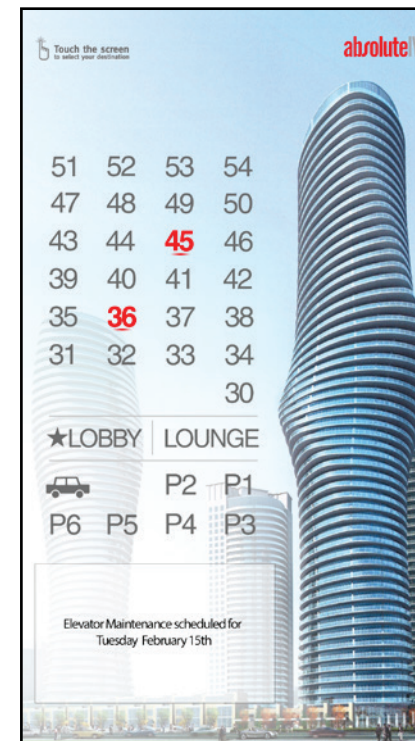

# TWO-WAY VIDEO

Our two-way video system allows the passenger to communicate with the Concierge/Security staff in the event of an emergency.

## KEY BENEFITS

- Ability to communicate with hearing impaired passengers or those with speech impediments.
- Remotely activate the camera and two-way video communication through a secure connection.
- Advanced attendant service functionality offered as an additional feature, which gives remote elevator control to the Concierge/Security desk. After the visitor is authorized, the Concierge/Security can dispatch the elevator to the desired floor.

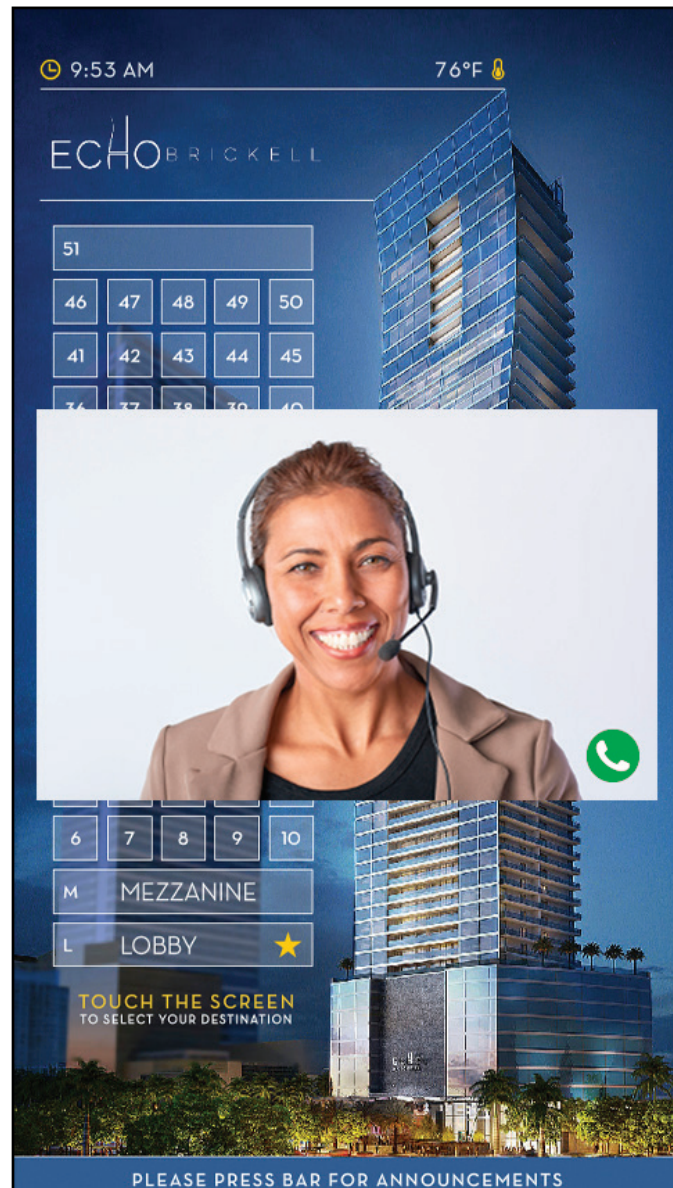

# DESTINATION DISPATCH

Touch-To-Go touchscreens are a convenient and elegant approach to implementing Destination Dispatch systems in the elevator car.

## KEY BENEFITS

- Next floor notification with tenant and branding.
- Interactive maps can help visitors navigate once in full Destination Dispatch mode.
- Digital Signage capability. Update and schedule from anywhere with an Internet connection.
- When control is needed within the car (e.g. Independent Service, Fire Service, or when the elevator is not in Destination Dispatch mode), screens can be activated to accept touch. This eliminates the need for redundant pushbuttons behind locked doors in cabinets.
- Ability to easily and automatically switch between Independent Service, Fire Service, and regular mode provides a smooth implementation and a better passenger experience during upgrades or overlay installation.

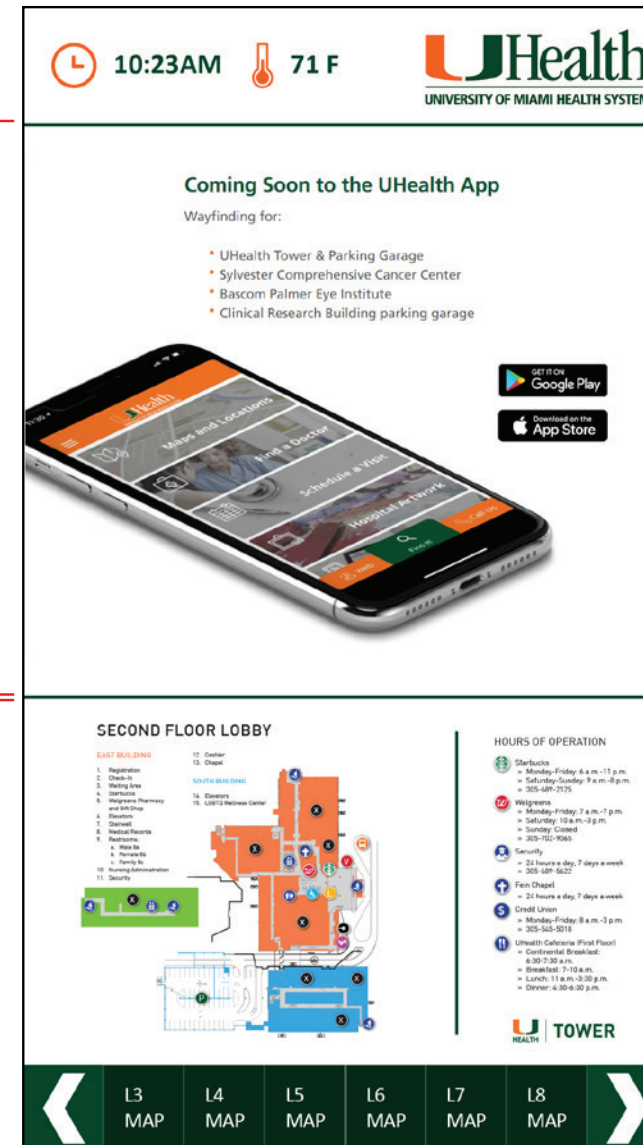

User-defined Area

Wayfinding



Instructions

# MANAGING CONTENT

MAD Elevator Inc. has an in-house team that provides complete design services. We work directly with the property manager to create custom themes tailored for your building.

If you wish to design themes yourself, files will need to be provided in vector format.

## USER GENERATED CONTENT

User-defined areas on the screen can be reserved for messages, custom graphics, information, or other custom content. This content can be updated without changing the rest of the graphics.

This space can be used for digital signage: hotels restaurant specials, museum exhibits, construction updates, or any other information a passenger might need to know.

The below examples use their space for announcements.

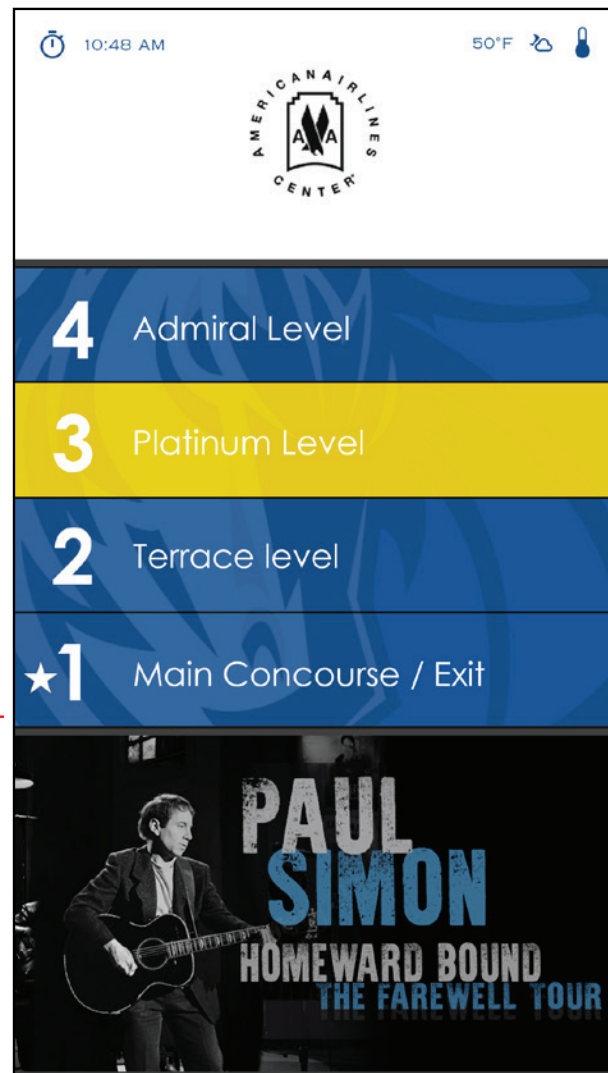

User-defined Area

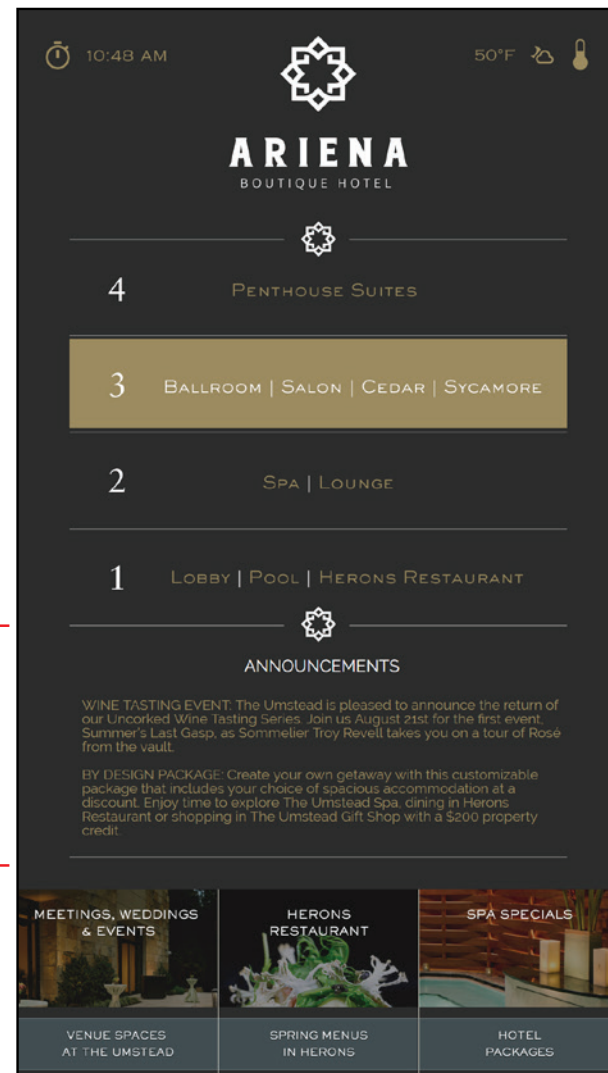

User-defined Area

# MosaicONE DIGITAL SIGNAGE SOFTWARE

MosaicONE is a cloud-native program by MAD Elevator Inc. that allows you to generate your own content using text, images, video, news/RSS feeds, time, weather or custom html. Preview, publish, and schedule content to your user-defined area at any time from anywhere with an Internet connection using any web browser. All your screens will be set up for you prior to your first time logging in.

If you also have a Matisse Position Indicator with MAD Elevator Inc., you can access your themes through the same interface.

## USER INTERFACE

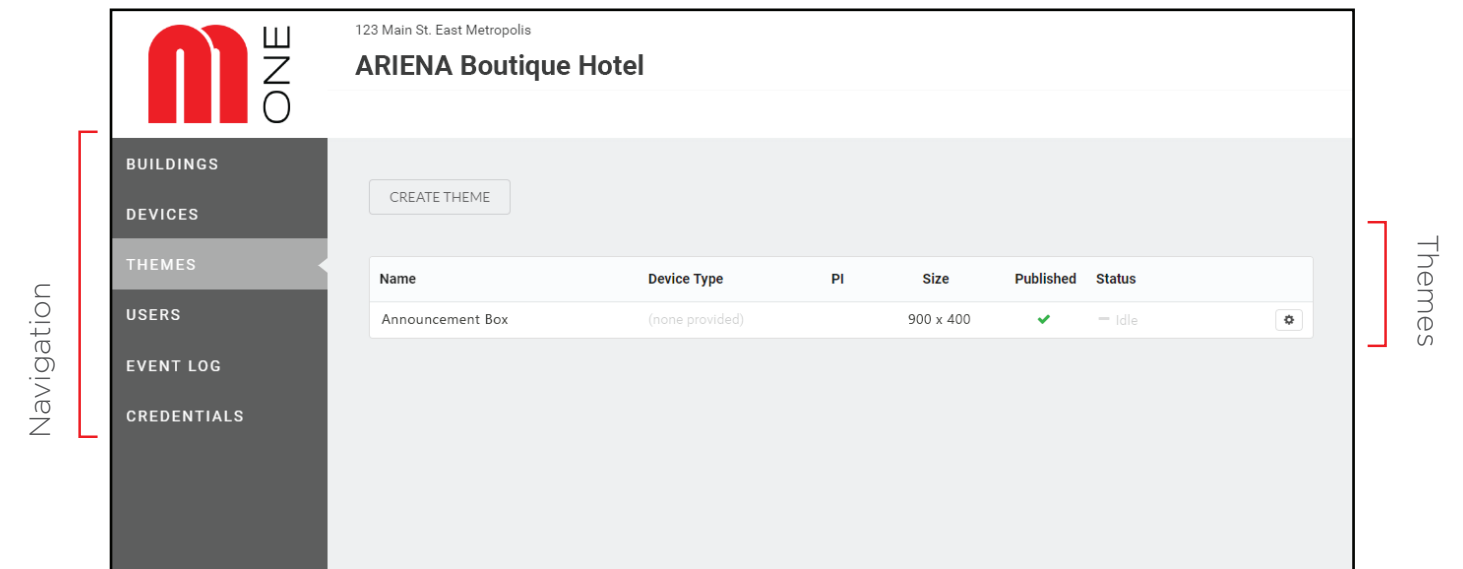

## EDITOR SCREEN

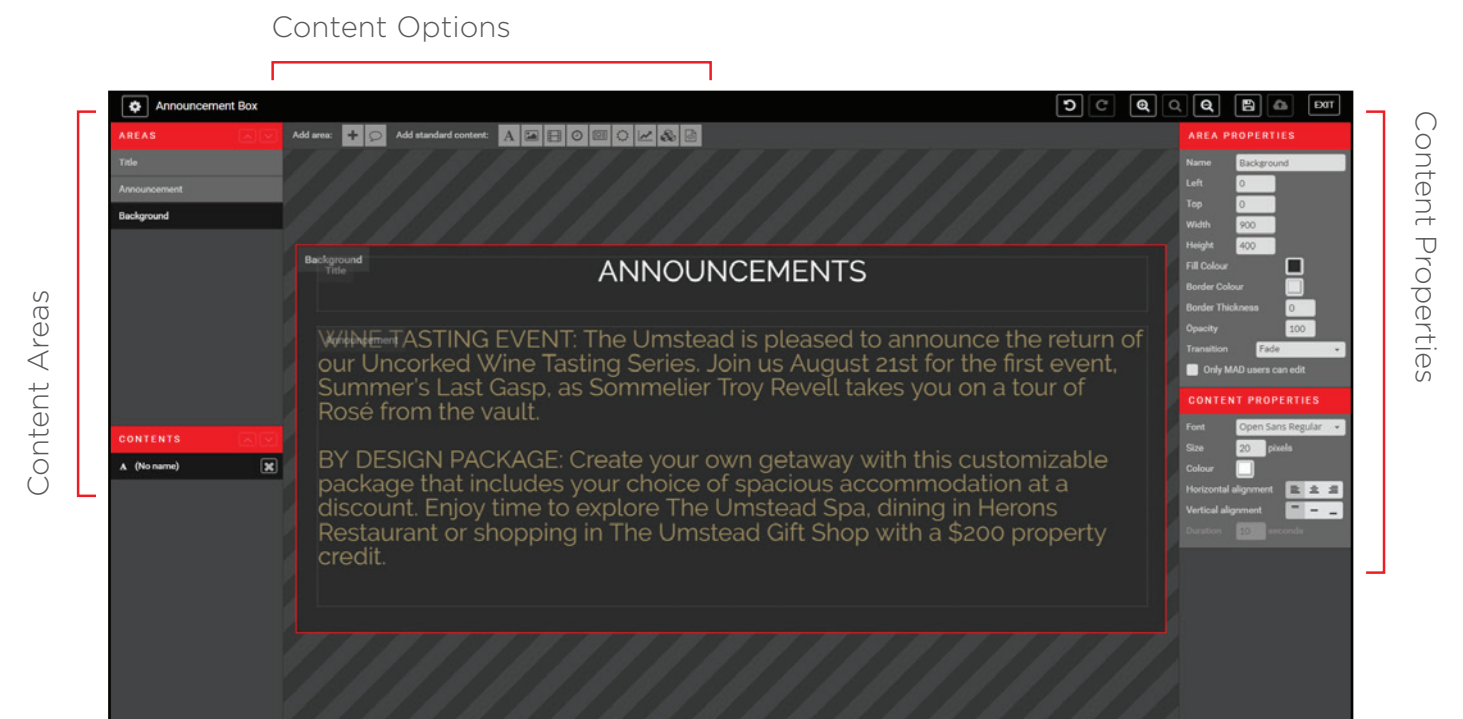

# COMPONENT LAYOUT

## KEYPADS

The keypad is a secondary method by which passengers can select their destination floor. It is intended for use by persons who are unable to use the touchscreen system (e.g. due to visual impairment or other disabilities).

The keypad complies with the 2010 ADA Standards for Accessible Design and ASME A17.1-2007 / CSA B44-07 Appendix E requirements for persons with physical disabilities. The keypad is also compliant with earlier codes CSA B44-00 and CSA B44-04. A special keypad is available meeting California requirements.

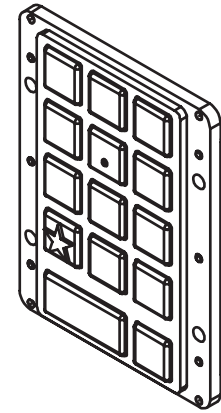

The keypad is approximately 4.25" x 5.75" in size, and markings for the non-numeric keys can be customized to meet the needs of each elevator.

## SERVICE PORT

The system's service port is located in the elevator's service cabinet. Along with two keyed switches, the service port allows for administration of the system without the need to open the car operating panels.

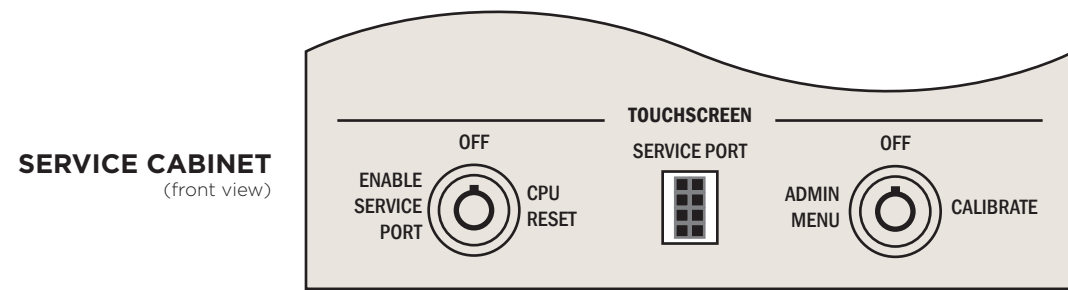

Three-position keyed switch  
Two independent sets of N.O. contacts  
Key removable in OFF position only  
Key trapped in other positions  
Spring-loaded in CPU RESET position only

Three-position keyed switch  
Two independent sets of N.O. contacts  
Key removable in OFF position only  
Key trapped in other positions  
Spring-loaded in ADMIN MENU position  
Spring-loaded in CALIBRATE position

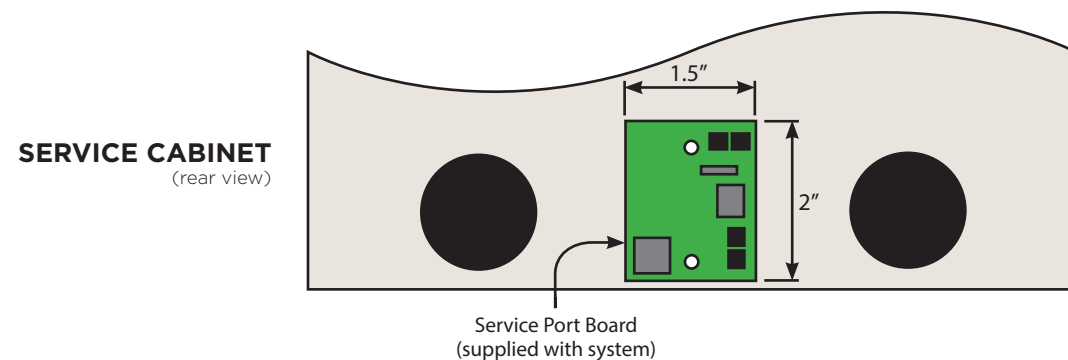

Service Port Board  
(supplied with system)

## ELEVATOR INTERFACE UNIT

The elevator interface unit is the device responsible for handling all communications between the elevator and the touchscreen system. It is mounted to the rear of the keypad.

It is fully electrically isolated from the elevator wiring. Destination floor requests are sent to the elevator via contact closures, and acknowledgements are received via illumination of LEDs, similar to conventional buttons. **In almost all cases, wiring is identical to what would be done for conventional buttons.**

The elevator button wiring connects to the elevator interface unit; all wiring for destination floor pushbuttons must be routed here. Cables from the elevator interface unit also connect to the service port in the service cabinet, and to the CPU panel. Sufficient clearance must be left around this device to allow for these connections.

Elevator interface units are available in multiples of 24 floors, supporting elevators with up to 24, 48, 72, or 96 stops. A CAN-bus unit is also available, greatly reducing field wiring requirements.

### STANDARD 3-WIRE CONNECTION

LED common, button common, and 1 wire per floor

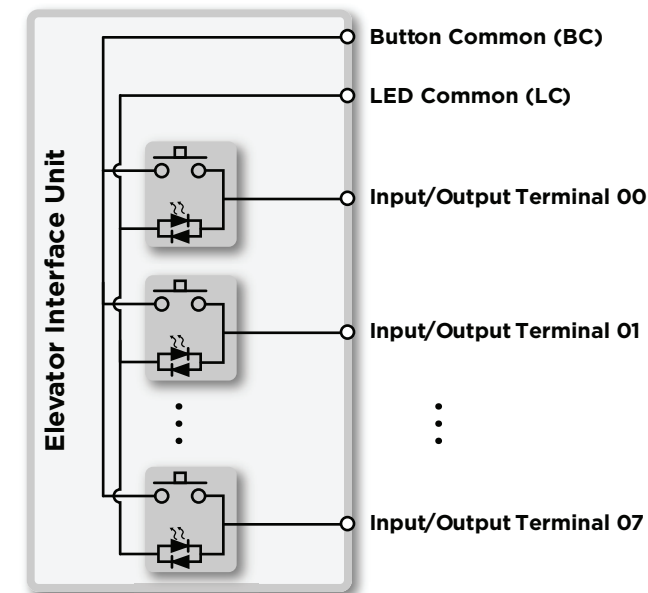

### OPTIONAL 4-WIRE CONNECTION

LED common, button common, and 2 wires per floor

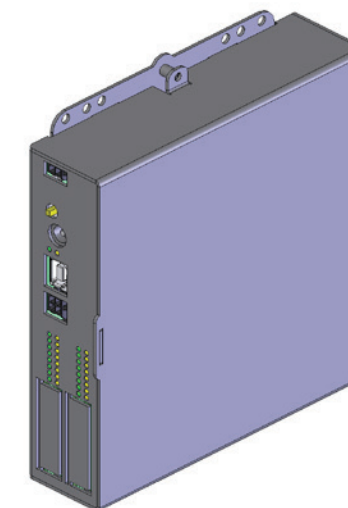
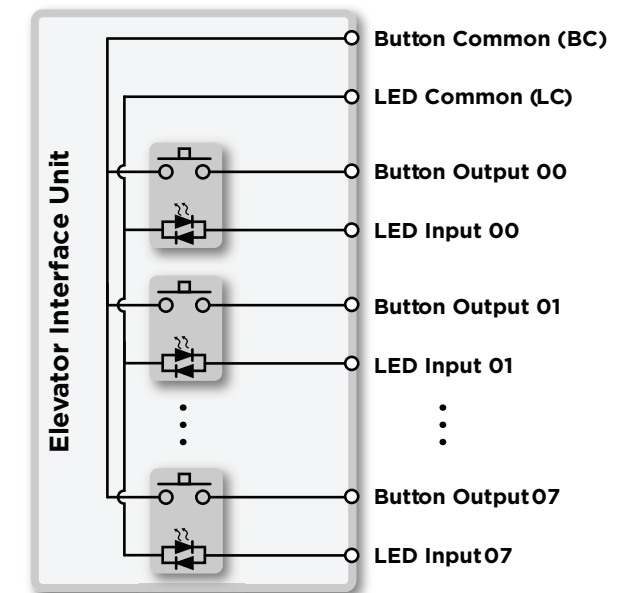

## 21W TOUCHSCREEN WITH INTEGRATED CPU

Our 21.5" touchscreen contains a robust and powerful integrated CPU, built directly into the touchscreen housing. For maximum reliability, the device is passively cooled and constructed from solid-state components with no moving parts or fans.

This integrated design greatly reduces space and wiring requirements within the COP, in addition to simplifying service and installation processes.

All wiring connections to other components terminate on the back of the touchscreen. Polarized connectors are used to prevent connection errors, and the use of locking connectors and cable clamps prevents cables from being accidentally dislodged.

The touchscreen is only 47.5mm (1 7/8") thick, making it easy to fit in most COPs.

A full-HD industrial-grade LCD panel is used, with a long-lifespan LED backlight and very wide viewing angles. This produces a crisp, bright, vivid image.

The 21W touchscreen is powered by a small 12VDC power supply separately mounted in the COP.

**IMPORTANT:** Passively cooled; keep away from other heat-generating equipment  
Leave clearance above and below for natural convection airflow

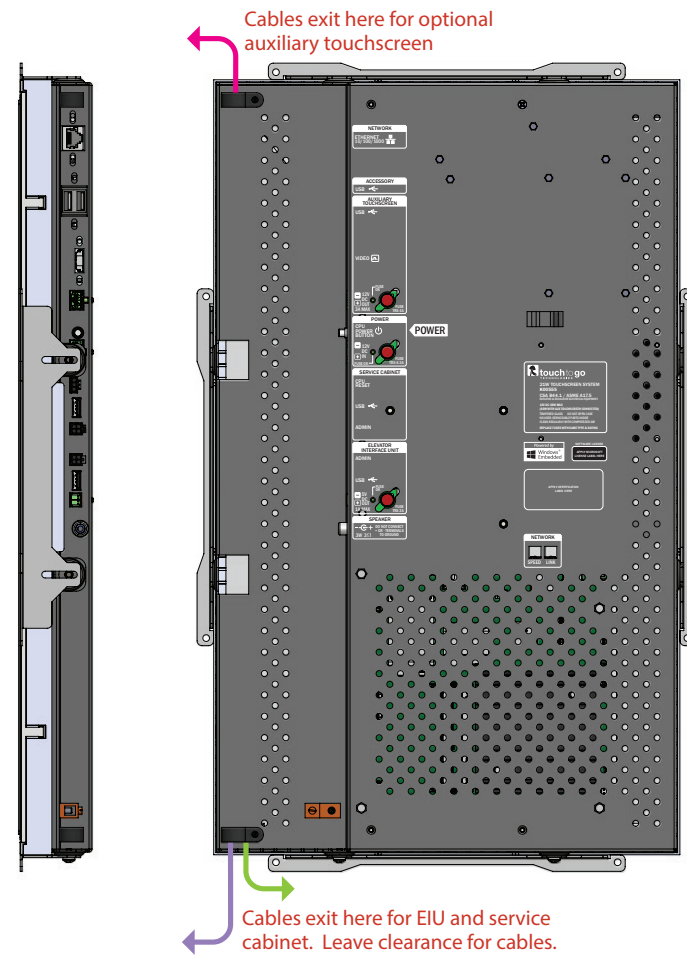

## OTHER TOUCHSCREENS - SPECIAL ORDER ONLY

The 21W touchscreen contains an internal CPU. Other sizes (available by special order) require a separate CPU panel which controls the operation of the touchscreens. It must be installed inside the car operating panel. Only one CPU panel is required per elevator, even if there are two touchscreens present. This CPU panel is 11.75" x 8.5" x 3.3". Please inquire for further details.

For maximum reliability, the CPU panel is constructed from solid-state components with no moving parts or fans.

AC power is connected to the system at the CPU panel. For dual car-operating panel elevators, mount the CPU panel in the lower portion of the COP. Cables to the other COP are routed out the bottom of the CPU panel and beneath the elevator doors.

## POWER AND WIRING REQUIREMENTS

The system requires an AC power connection of 100-120V AC 3.5A MAX, 50-60Hz or 200-240V AC 2A MAX, 50-60Hz and is to be connected to a maximum 20A branch circuit. Conductors shall be Cu, Al, or Cu-Al, and the ground wire must be 14AWG. Typical power consumption is 40-60W.

The AC power must come from a reliable uninterrupted source of power to keep the system operational. This connection is made at the CPU panel. All components outside of the CPU panel operate from low voltage DC power supplied by the CPU panel.

Electrical codes generally require a dedicated circuit for car lighting; therefore it is advised that the touchscreen system be supplied by an alternate circuit. The circuit powering the touchscreen system must shut off when the main power to the elevator control is shut off.

### EMERGENCY CONTROLS AND DOOR OPEN/CLOSE

Emergency controls, door open, door close, etc. should be implemented with conventional pushbuttons; the touchscreen only supports selection of the destination floor.

### NETWORKING (optional)

Multiple elevators can be networked together to simplify processes such as system configuration or graphics updates.

If systems are to be networked, a one sided twisted-pair must be included in the traveling cable. Devices to extend interior from controller to elevator car are used, and connections to devices are made with CAT5 cables. An internet access point is provided in the machine room and ranked to each controller.

### POWER SAVING MODE (optional)

Touch-To-Go Elevator Touchscreen Systems include a power-saving mode which can turn off the touchscreens after a configurable period of inactivity. This prolongs the life of the LCD.

# INSTALLATION

Installation of a Touch-To-Go touchscreen system is straightforward. Car operating panels can be supplied with the equipment installed, prewired, and tested. This reduces on-site labour and makes the process as simple as possible.

For customers who wish to install the system in their own COPs, a detailed installation manual is provided with each order. The process is simple and steps can be summarized as follows:

- Mount the touchscreen to the cutout and studs in the COP
- Mount the keypad to the cutout and studs in the COP
- Mount the elevator interface unit to the rear of the keypad
- Mount the CPU panel to the studs in the COP
- Mount the service port board to the studs in the service cabinet
- Connect the keyed switches to the service port board
- Connect the cables (supplied) from the CPU panel to each of the other components
- Connect the elevator button wiring to the elevator interface unit
- Connect power to the CPU panel

Systems are shipped preloaded with graphics for each job, and preprogrammed with the required operating parameters. They are ready to use upon power-up, and in most cases, no on-site programming or configuration is needed.

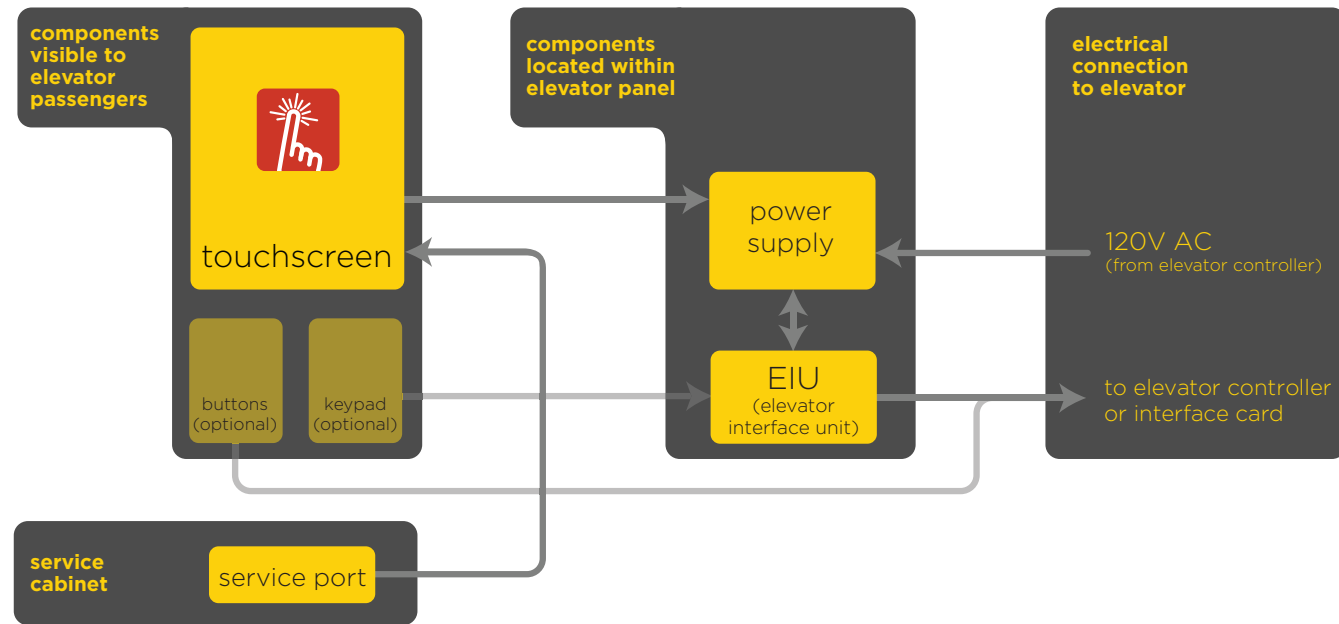

Block Diagram - Equipment Connections

**i** The information in this document has been provided to assist with designing a code-compliant car operating panel. In this document, the term 'code-compliant' is intended to specifically refer to codes addressing use by persons with disabilities; it does not refer to more general elevator or safety codes, compliance with which must be verified separately. The document may contain unintentional errors or omissions, and codes and standards may have changed since the document was prepared. Touch-To-Go Technologies does not guarantee that the information in this document is applicable to all jurisdictions; you are responsible for verifying all details pertaining to your installation.

# CODE COMPLIANCE

When installing an elevator touchscreen system, it is important to consider use of the system by disabled passengers and ensure that the elevator car meets all necessary codes pertaining to accessibility.

An elevator touchscreen system can provide greater accessibility to visually impaired passengers. Through the use of larger, high contrast virtual buttons, information is more readily available. The touchscreen requires only 55 grams of force to operate, which is less than a traditional pushbutton.

However, there may be cases where a passenger is unable to operate the touchscreen, and in these cases it is important to comply with applicable codes and standards. Two options are available for achieving compliance with codes specific to use by the disabled: the touchscreen may be coupled with a keypad, or with a set of conventional buttons.

## KEYPAD - SPEECH OUTPUT

The disability access requirements of the City and County of San Francisco Department of Building Inspection require keypad console speech output. This section details the speech-related features available on the Touch-To-Go product.

Note that speech output requires a dedicated loudspeaker (3Ω, 3W) to be provided as part of the car operating panel; this can be supplied by Touch-To-Go, or a customer-supplied speaker can be used if available.

Speech output is offered as an option for California keypads as well as for standard keypads.

Item	City and County of San Francisco Department of Building Inspection, Administrative Bulletin #AB-090	Touch-To-Go System
Verbal announcement of floors served	When the Accessibility Function key is pressed, a verbal announcement of floors served by the elevator group shall be provided.	When the Accessibility Function key is pressed, the system can speak a user-configurable phrase that can describe the floors served.
Instructions	After the Accessibility Function key is pressed, a speech prompt shall direct the user to enter a destination floor.	When the Accessibility Function key is pressed, the system can speak a user-configurable phrase that instructs the user to enter their destination floor. Note that this phrase is independent of and in addition to the announcement of floors served.
Announcement of keypad entry	When a destination floor has been entered on the keypad or through an access control system, a speech prompt will, within two seconds, indicate the destination floor that was entered.	When a destination floor has been entered on the keypad, a speech prompt will indicate the destination floor that was entered. This happens within two seconds of the entry being accepted.
Invalid entries	The keypad console shall make an audible indication of an invalid key press sequence.	The keypad will make a beep tone if the key sequence is not valid.
Speech volume	Auditory volume shall be at least 10dBA above ambient sound level, but not more than 80 dBA.	Volume is to be set by the installer of the equipment.
Relevant section of the bulletin	Section I, part E (Keypad Console Speech Output)	



## STANDARD KEYPAD

The following drawings and table are provided to help confirm the standards compliance of the keypad.

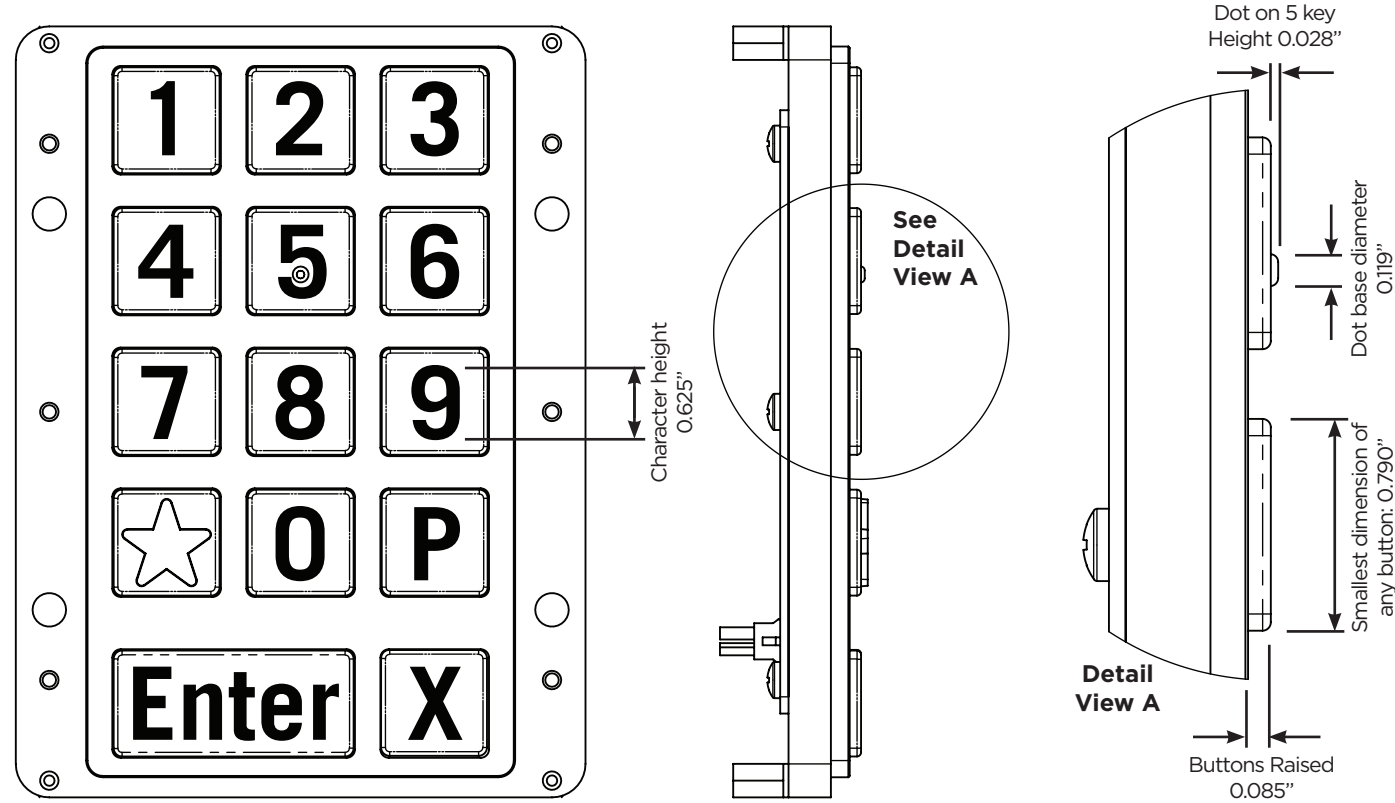

Item	Touch-To-Go Keypad	ASME A17.1-2007 CSA B44-07 Appendix E	ANSI A117.1 1998	2010 ADA Standards for Accessible Design
Numerical key arrangement	Standard telephone sequence	Standard telephone sequence	Standard telephone sequence	Standard telephone sequence
Button Size	0.790"	Minimum 0.750"	Minimum 0.750"	No requirement defined
Button Height	0.085"	Minimum 0.060"	Raised or flush	No requirement defined
Operating Force	Finger-activated; less than 1 pound force to operate.	No requirement defined	No requirement defined	Operable by one hand, no grasping, pinching, or twisting. Max 5 pounds force to operate.
Character Height	0.500" (Canada only) 0.625" (Canada or USA)	Minimum 0.500"	No requirement defined (elevators excluded from character height requirements)	Minimum 0.625"
Character Placement	Centered	Centered	Centered	Centered
Character Font	High contrast, non-glare Conventional character forms Black on matte silver	High contrast, non-glare Conventional character forms	High contrast, non-glare Conventional character forms	High contrast, non-glare Conventional character forms
Dot on '5' key	Base diameter 0.119" Height 0.028"	Base diameter 0.118 -0.120" Height 0.024-0.031"	Base diameter 0.118 -0.120" Height 0.025-0.037"	Base diameter 0.118 -0.120" Height 0.025 to 0.037"
Main entry floor	Five-pointed star to indicate main entry floor	Five-pointed star to indicate main entry floor	Five-pointed star to indicate main entry floor	No requirement defined
Visual display	Touchscreens will show registered car destinations	Visible indicators must show registered car destinations	Visible indicators must show registered car destinations	Visible indicators must show registered car destinations
Relevant sections of each standard		E-9.5 (car control keypads) E-20.4 (characters)	407.2.11.1 (car control buttons) 407.2.11.2 (keypads) 703.4 (characters)	407.4.6.3 (key arrangement) 407.4.7.2 (keypads) 703.5 (characters) 309.4 (operating force)

## CALIFORNIA KEYPAD

A special keypad design is available to address the disability access requirements of the City and County of San Francisco Department of Building Inspection. The following drawings and table are provided to help confirm the standards compliance of this keypad. Because this keypad also complies with the standards mentioned on the previous page, those will not be repeated here.

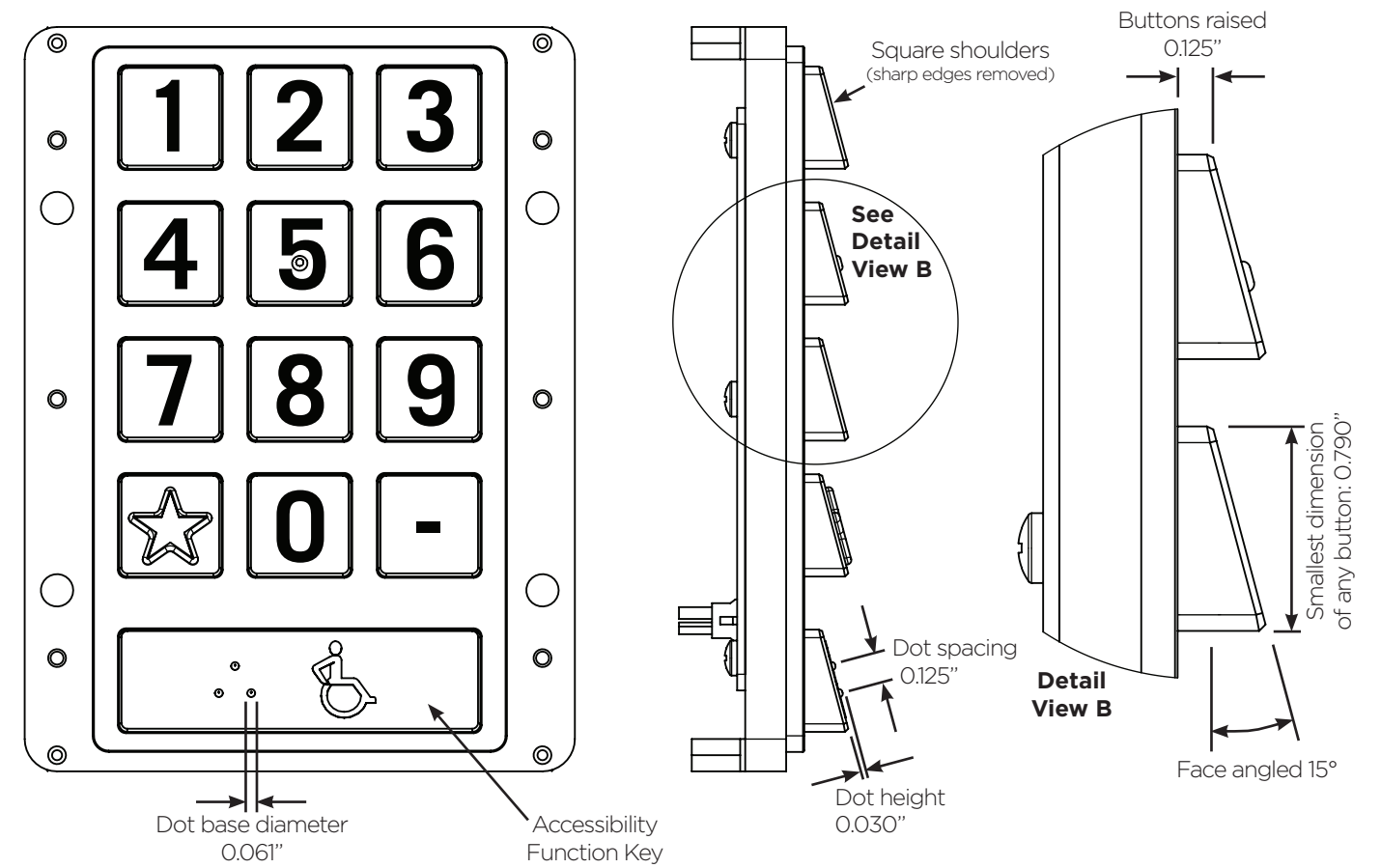

Item	City and County of San Francisco Department of Building Inspection, Administrative Bulletin #AB-090	Touch-To-Go Keypad
Numerical key arrangement	Standard telephone sequence, 12 keys	Standard telephone sequence, 12 keys
Button Size	0.750" minimum	0.790"
Button Height	0.125" minimum	0.125"
Button Shape	Square shoulders, no sharp corners or edges	Square shoulders on face, sharp edges removed
Button Slope	15° to 25°	15°
Character Font	White characters on a black surface	White characters on a black surface
Minus key	Minus sign on key in lower right corner	Minus sign on key in lower right corner
Star key	Five-pointed star key in lower left corner dispatches elevator to main entry floor	Five-pointed star key in lower left corner dispatches elevator to main entry floor
Accessibility function key	Below numeric keys, rectangular or square in shape, larger than other keys, contains ISA and raised triangle symbol	Below numeric keys, rectangular, larger than other keys, contains ISA and triangle symbol
Button action	Mechanical, detectable motion	Mechanical, moves when pressed
Additional keys	If present, additional keys must be to the right of the numeric keypad, with raised lettering and braille.	No additional keys
Relevant section of the bulletin	Section I, part C (keypad)	

## ACHIEVING COMPLIANCE USING CONVENTIONAL BUTTONS

For buildings whose elevators serve a small number of floors, one to two rows of compact conventional pushbuttons may be located beneath the touchscreen. For elevators with dual car operating panels, this set of buttons is typically only required on one of the two panels in order to achieve compliance with disability and accessibility codes.

For the purposes of evaluating code compliance, the buttons can be considered to be the primary means of operating the elevator, and the touchscreen can be considered as being supplemental to the buttons. As long as the buttons are installed in a manner that complies with disability and accessibility codes, no further changes are needed as a result of the presence of the touchscreen.

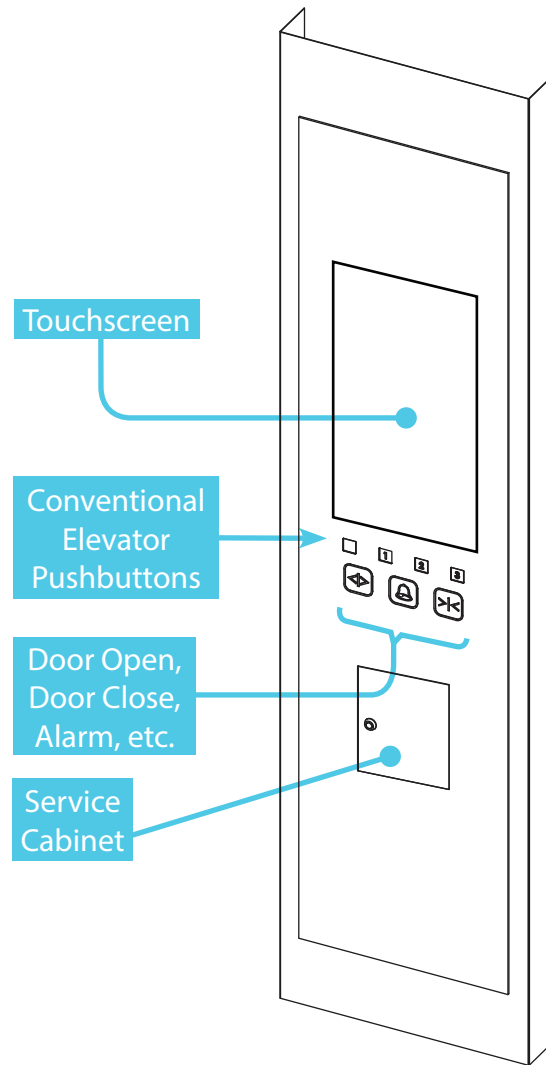

## ACHIEVING COMPLIANCE USING A KEYPAD

For buildings whose elevators serve a moderate to large number of floors, a tactile keypad is available for entering a destination floor.

The keypad is compliant with the requirements of ANSI A117.1 and ASME A17.1 / CSA B44 Appendix E-9.5 and the 2010 ADA Standards for Accessible Design. It contains a dedicated ground floor button and automatically rejects invalid call requests. The keypad is a space-efficient solution for achieving code compliance in buildings with a large number of floors. For elevators with dual car operating panels, only one keypad is required or supported per elevator.

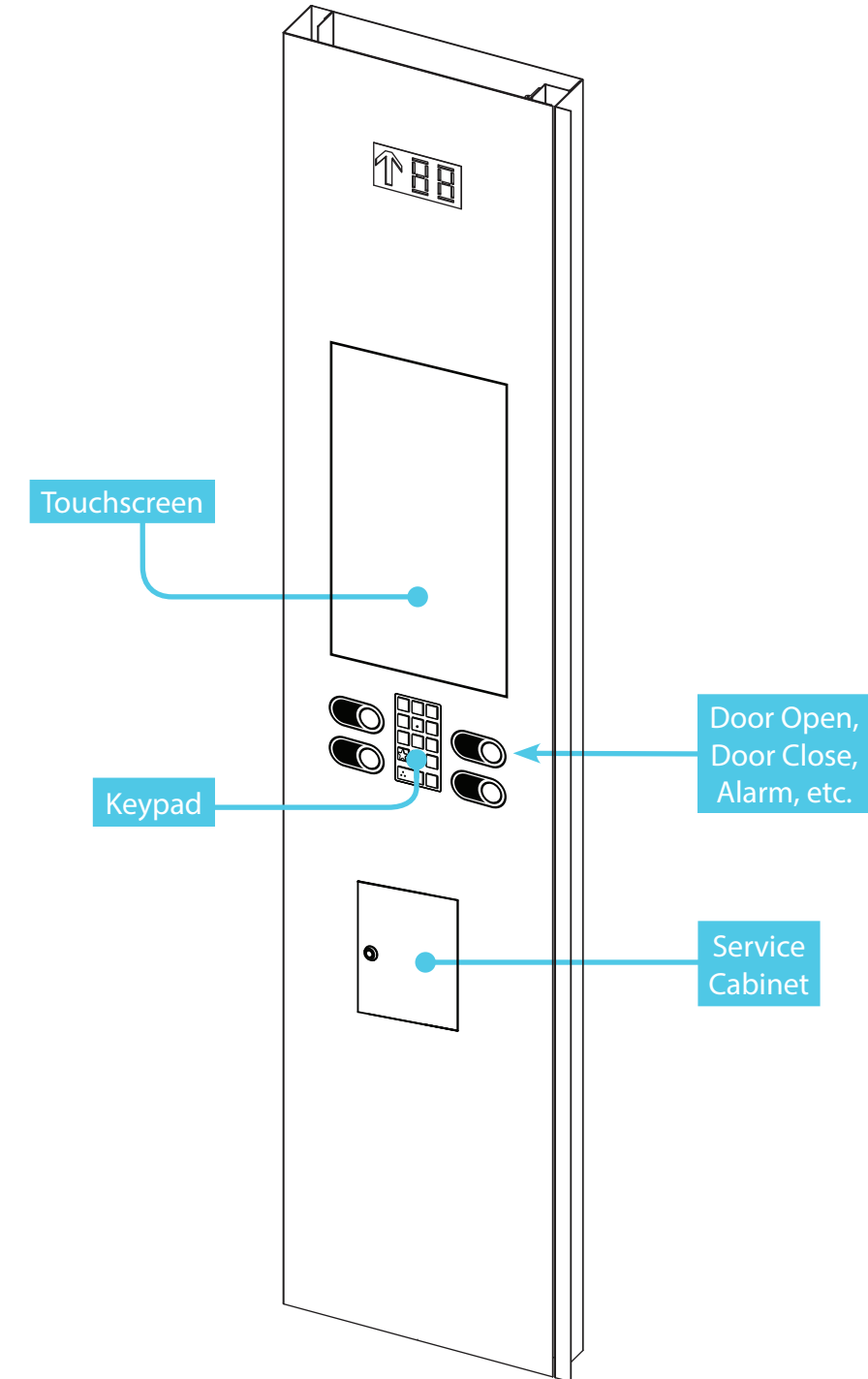

# SPECIFICATIONS

ITEM	SPECIFICATION
Operating Temperature Range	Touchscreen and CPU: 0°C to 50°C (operating), -20°C to 60°C (storage) Keypad and Elevator Interface Unit: -20°C to 60°C
Standards Conformance, System	Elevator and Escalator Electrical Equipment Conforms to ASME A17.5-2011 Certified to CSA B44.1-11, Fourth Edition Intertek/ETL-listed as a Recognized Component (C/US)
Standards Conformance, Keypad	CSA B44-07 Appendix E (and older editions -00 and -04) ASME A17.1-2007 Appendix E (and older editions 2000 and 2004) ANSI A117.1-2003 and 1998 (and proposed 2008 standard) ADA Standards for Accessible Design, 2010 edition
Fail-Safe Operation	In a system with two touchscreens, in the event of failure of one touchscreen, the other touchscreen remains operational.  In a system with keypads, in the event of a failure of the touchscreen(s) or CPU, the keypad remains operational. Power is required for the keypad to operate and it is recommended that the system be supplied by an uninterrupted source of emergency power.  In systems with conventional elevator buttons, in the event of a failure of the touchscreen(s) or CPU, the elevator may still be operated by conventional elevator buttons.
Emergency Recall / Fire Service	The Touch-To-Go elevator touchscreen system does not affect the ability of the elevator to respond to emergency recall or fire service requests.
Fire Retardation	The touchscreen meets UL standard 94HB.
Vandalism / Breakage Resistance	Touchscreens are constructed from tempered glass with a safe break pattern. They contain no overlays or coatings to wear out, scratch, or tear. The touchscreen meets the UL-60950 and CSA 22.2 No. 60950 ball drop test requirements (0.5 kg, 50 mm diameter ball dropped from 1.3 m).
Electrostatic Protection	The touchscreen meets Level 4 (15 kV air/8 kV contact discharges) per EN 61 000-4-2, 1995.
Chemical resistance	The active area of the touchscreen is resistant to all chemicals that do not affect glass, such as acetone, toluene, methyl ethyl ketone, isopropyl alcohol, methyl alcohol, ethyl acetate, ammonia-based glass cleaners, gasoline, kerosene, and vinegar.

 This document may contain unintentional errors or omissions, and codes, standards, or product specifications may have changed since this document was prepared. Touch-To-Go Technologies does not guarantee that the information in this document is applicable to all jurisdictions; you are responsible for verifying all details pertaining to your installation.

# APPROVALS

The following letter was received by MAD Elevator Inc. following a presentation of the Touch-To-Go Elevator Touchscreen System to the New York City Department of Buildings Elevator Unit. The system was approved by New York City and found to be in compliance with all applicable codes. Please verify compliance with local codes in your area; we are happy to assist with any questions you may have.

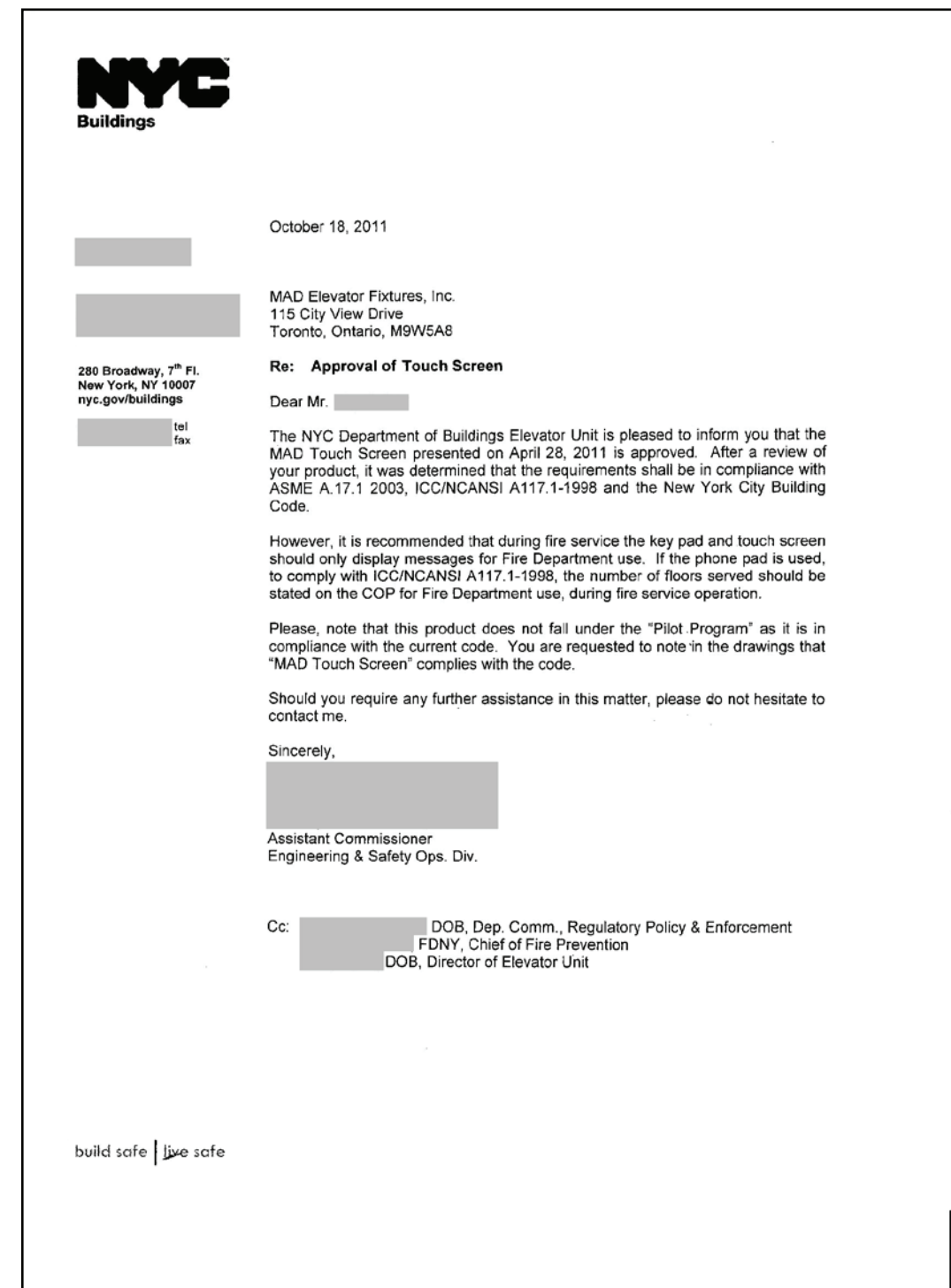



FIREFIGHTERS' OPERATION



MAXIMUM CAPACITY  
1000 KG OR 10 PERSONS

FLOOR  
2



6635 ORDAN DRIVE  
MISSISSAUGA, ONTARIO  
CANADA L5T 1K6  
1 (866) 967-8500

[sales@madelevator.com](mailto:sales@madelevator.com)  
[www.madelevator.com](http://www.madelevator.com)

© MAD Elevator Inc.

*Part of DMG Group of Companies*